

5 55 125 5

eibe ibondo Climbing Frame with Double Horizontal Bars







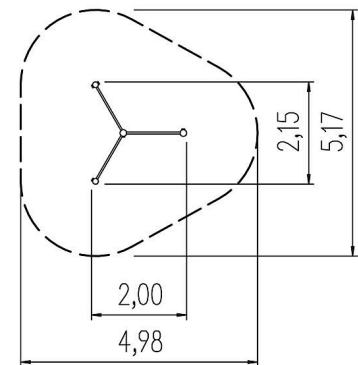
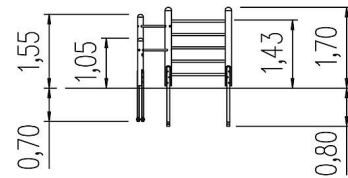

made in germany

4+

Scope of delivery

- 1 rung element: SW, ash
- 2 posts: SW
- 2 horizontal bars: hot-dip galvanised and powdered steel
- Post shoes: hot-dip galvanised steel



| | | |
|---|-----------------------|---------------------|
|  | Material | SW pi |
|  | Foundation level | FL 3 |
|  | Minimum space | 517x498x323 cm |
|  | Free falling height | 143 cm |
|  | Impact protection net | 18,5 m ² |
|  | Foundations | 4x CF |
|  | Assembly | 1 person/2 h |
|  | Largest section | 250x140x14 cm |
|  | Heaviest section | 70 kg |