

5 55 120 5

## eibe ibondo Two-Level Horizontal Bars







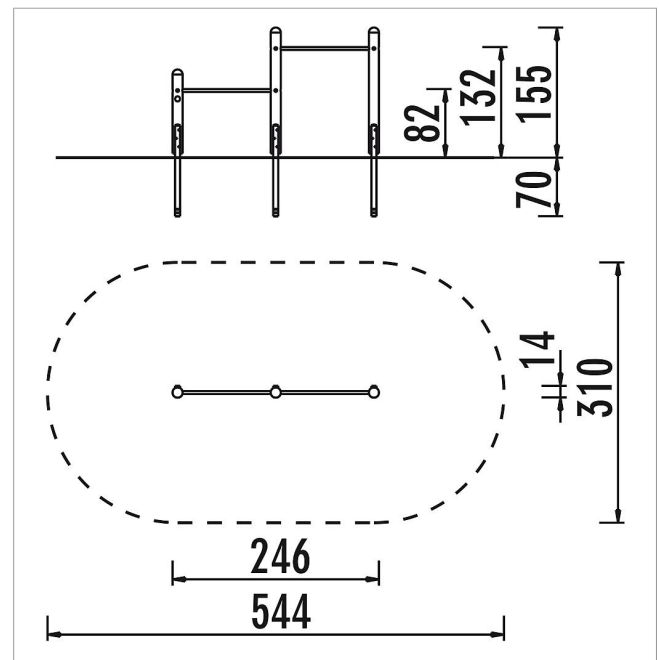

made in germany

4+

### Scope of delivery

3 posts: SW  
2 horizontal bars: hot-dip galvanised and powdered steel  
Post shoes: hot-dip galvanised steel



	Material	SW pi
	Foundation level	FL 3
	Minimum space	544x310x312 cm
	Free falling height	132 cm
	Impact protection net	14 m <sup>2</sup>
	Foundations	3x CF
	Assembly	1 person/1 h
	Largest section	150xØ 12 cm
	Heaviest section	15 kg