



Altitude, it's another level

design
make
play
SutcliffePlay

Sutcliffe Play Ltd
Waggon Lane
Upton
Pontefract WF9 1JS
United Kingdom

Tel: +44 (0)1977 653 200
info@sutcliffeplay.co.uk
www.sutcliffeplay.co.uk

Registered in England
No.435546

Registered Office as above



Design by browndogagency

design
make
play
SutcliffePlay





The Expedition Begins!

When we first embarked on the challenge of designing our brand new junior-focused range, we did so with one simple principle in mind - that to a child, the least exciting part of any playground... is the ground!



That meant the only way was up - and today, peak play is here to stay with our latest creation... **Altitude!**

This majestic range introduces an awesome 11 new units, each inspired by the timeless thrill of the climb, and all packed with a host of challenging play features for juniors aged 6-14!

But Altitude is much more than a new range, it's a recognition of the fact that to a child, climbing means horizons expanded, heights scaled, and goals smashed. Altitude is the perfect outlet for that playful instinct, with its challenging design ethos guaranteed to get intrepid young explorers heading up, up, up!



Reach for the Summit



A wide range of junior-focused features, across decks at both 1.5m and 1.8m high, help children develop their balance, co-ordination and stamina as they reach for the skies – and like any fulfilling adventure, they come with a slight touch of risk!

Best of all, despite Altitude's mountainous theming, its greatest achievement is its small footprint, with each unit delivering a market leading quantity of play opportunities within the smallest possible safety surfacing area.

All of which means that whatever the size of their local playground, children everywhere are about to take up the challenge of conquering Altitude – and one climb simply won't be enough!

Built to last

Fun for all

This massive new range includes a huge variety of new equipment, comprising not only a number of small, cost-saving units but also many larger, multi-tower ones. Regardless of scale, however, each is packed with thrilling features to inspire the most exhilarating ascent possible, with standouts including:

- Numerous ways to enter and climb each unit, including vertical rungs, turnpike climbers, summit climbers, and switchback climbing walls, all making for the most testing of journeys to challenge any junior's stamina.
- A range of nets and bridges between towers, including side to side net bridges, V bridges, stepping stone bridges and more, enabling thrilling mid-air journeys and many games and interactions between friends.
- An array of swift and exhilarating ways to return to Earth, including stainless steel slides (Bedway and regular), challenging slide bars and zoom poles.
- Below-deck social seating, for children to relax and interact in a sheltered location.
- A range of colourful mountain-themed play panels at various levels, to add visual engagement and offer social and tactile play.

Key Features

Many of the new units also include unique elements which enhance their visual style, such as mountain-themed routing on panels, as well as feature flags and grey ridged roofs.

But Altitude doesn't just look great alone, it also makes an excellent aesthetic companion to our recent Fantasy range, with all of its units offering the same vibrant mixture of colours, including striking blue and pistachio green panels, vivid orange and light grey poles, and warm grey on the floors and steel activities.



Posts & Poles

All upright posts are square, zinc-rich powder coated mild steel, 80mm x 80mm with a 3mm wall. This high-quality material is powder coated using a sustainable electrostatic process proven to withstand the rigours of daily use and the harshest of outdoor environments.

All poles are zinc-rich powder coated and manufactured from 38mm x 10swg steel tubing.

We use a local supplier for these poles and posts whose mild steel includes an average of 76% recycled content.



Panels

Our high-quality HDPE panels are supported by mild steel powder coated box steel posts. At 19mm thick, they offer an excellent strength-to-density ratio and very high impact resistance.

HDPE is an extremely versatile thermoplastic polymer, which is used to manufacture our play panels as well as other components across our product ranges. Our HDPE is sustainably sourced and easily recyclable, and includes an average of more than 85% recycled content.



Decks

Our anti-slip floor panels are manufactured from 15mm thick grip profiled HDPE to ensure a very long life, and they're supported by a 50 x 30mm powder coated box steel construction.

HDPE is resistant to mould and rotting, as well as most strong mineral acids and naturally occurring chemicals. It is also easily recyclable, helping to keep non-biodegradable waste out of landfill.



Slides

Many of the units have bedway or all-stainless-steel slides set at various heights, which are manufactured as a one-piece stainless steel structure with additional support along the run-out section. The stainless steel in our products is durable, maintenance free, easy to clean, and suitable for all environments. It is also sourced from a local enterprise whose steel output includes a recycled content of between 85% and 90%.



Nets

Using nets on our play equipment helps to develop co-ordination, strength and confidence as well as giving a little challenge.

The durable 16mm steel-cored rope we use offers great durability, allowing it to endure heavy sustained usage for long periods without requiring replacement, helping to minimise wastage.

For full warranty details, please visit www.sutcliffeplay.co.uk

Ridge

MNW001



5

PLAY VALUES

5 Physical & Locomotor

5

USERS

5

PLAY FEATURES

- 1.5m high stainless steel bedway slide
- Vertical rungs
- Zoom pole
- Mountain trek pathway panel
- Feature flag

Technical Spec

DETAILS

- 6 - 14 years
- 1.5m
- 21.43m²
- 17.75m
- 3.025m

Layout Plan

OVERHEAD

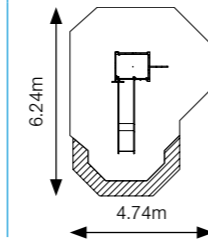

Crag

MNW002



6

PLAY VALUES

- 3 Physical & Locomotor
- 2 Role Play & Imaginative
- 1 Object

6

USERS

6

PLAY FEATURES

- 1.8m high slide bars
- Cross climber
- Staggered climber
- Roof, binocular / graphic panel
- Searcher panel (at ground level)

Technical Spec

DETAILS

- 6 - 14 years
- 1.8m
- 24.33m²
- 18.72m
- 3.945m

Layout Plan

OVERHEAD

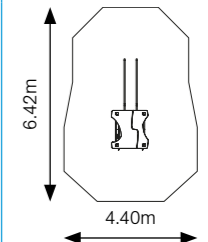

Tor

MNW003



9

PLAY VALUES

- 6 Physical & Locomotor
- 2 Role Play & Imaginative
- 1 Object

13 USERS

9

PLAY FEATURES

- 1.5m stainless steel bedway slide
- 'V' bridge
- Summit climber
- Zoom pole
- Vertical rungs
- Switchback climbing wall
- Seat under tower
- Feature flag & mountain trek pathway panel

Technical Spec

DETAILS

- 6 - 14 years
- 1.5m
- 33.19m²
- 23.52m
- 3.025m

Layout Plan

OVERHEAD

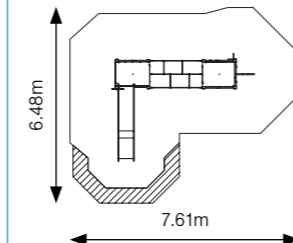

Cuesta

MNW004



10

PLAY VALUES

- 7 Physical & Locomotor
- 2 Social
- 1 Object

12 USERS

10

PLAY FEATURES

- 1.5m stainless steel bedway slide
- 'V' bridge
- Summit climber
- Zoom pole
- Vertical rungs
- Turnpike post climb
- Switchback climbing wall
- Seat under tower
- Mountain trek pathway panel
- Feature flag and roof

Technical Spec

DETAILS

- 6 - 14 years
- 1.5m
- 33.27m²
- 23.58m
- 3.635m

Layout Plan

OVERHEAD

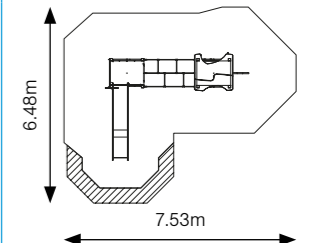

Mesa

MNW005



10

PLAY VALUES

- 7 Physical & Locomotor
- 2 Social
- 1 Object

12

 USERS





10

PLAY FEATURES

- 1.5m stainless steel slide
- Step / traverse net
- Searcher panel (at ground level)
- Binocular / graphic panel
- Summit climber
- Zoom pole
- Vertical rungs
- Staggered rungs
- Feature flag and roof

Technical Spec

DETAILS

-  6 - 14 years
-  1.5m - 1.8m
-  39.05m²
-  26.98m
-  3.945m

Layout Plan

OVERHEAD

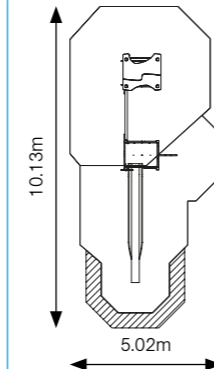

Rift

MNW006



13

PLAY VALUES

- 8 Physical & Locomotor
- 2 Social
- 2 Object
- 1 Role Play & Imaginative

19

USERS

13

PLAY FEATURES

- 1.5m all stainless steel slide
- 'V' bridge
- Summit climber
- Zoom pole
- Vertical rungs
- Turnpike post climb
- Switchback climbing wall
- Seat under tower
- Step / traverse net
- Staggered climb
- Mountain trek pathway panel
- Binocular / graphic panel
- Searcher panel (at ground level) and roof

Technical Spec

DETAILS

- 6 - 14 years
- 1.5m - 1.8m
- 47.44m²
- 26.66m
- 3.945m

Layout Plan

OVERHEAD

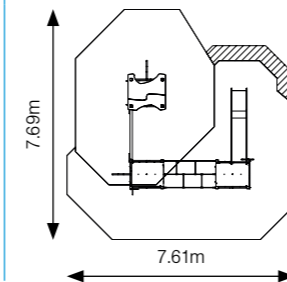

Stack

MNW007



13

PLAY VALUES

- 8 Physical & Locomotor
- 2 Social
- 2 Object
- 1 Role Play & Imaginative

19

USERS

13

PLAY FEATURES

- 1.5m all stainless steel slide
- 'V' bridge
- Summit climber
- Zoom pole
- Vertical rungs
- Turnpike post climb
- Switchback climbing wall
- Seat under tower
- Step / traverse net
- Staggered climb
- Mountain trek pathway panel
- Binocular / graphic panel
- Searcher panel (at ground level) and roof

Technical Spec

DETAILS

- 6 - 14 years
- 1.5m - 1.8m
- 50.83m²
- 28.47m
- 3.945m

Layout Plan

OVERHEAD

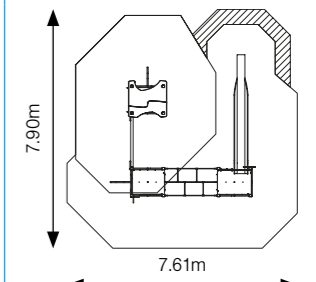

Scree

MNW008



15

PLAY VALUES

- 8 Physical & Locomotor
- 3 Object
- 2 Social
- 2 Role Play & Imaginative

19

USERS





15

PLAY FEATURES

- 1.5m stainless steel bedway slide
- 'V' bridge
- Summit climber
- Zoom pole
- Vertical rungs
- Turnpike post climb
- Switchback climbing wall
- Seat under tower
- Step / traverse net
- Slide bars (1.8m)
- Binocular / graphic panel
- Searcher panel (at ground level)
- Feature flag
- Mountain trek pathway panel and roof

Technical Spec

DETAILS

-  6 - 14 years
-  1.5m - 1.8m
-  51.35m²
-  28.90m
-  3.945m

Layout Plan

OVERHEAD

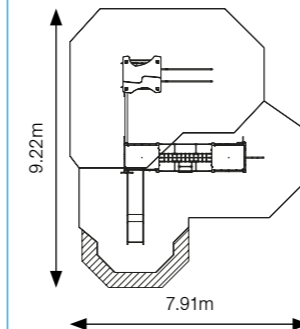

Karst

MNW009



20

PLAY VALUES

- 15 Physical & Locomotor
- 2 Social
- 2 Object
- 1 Role Play & Imaginative

27

USERS





20

PLAY FEATURES

- 1.5m stainless steel bedway slide
- Stepping stone bridge
- Side to side bridges x2
- Hand over hand
- "V" bridge
- Summit climber
- Zoom pole
- Vertical rungs
- Turnstile climber
- Switchback climbing wall
- Seat under tower
- Step / traverse net
- Slide bars (1.8m)
- Binocular / graphic panel
- Searcher panel (at ground level)
- Cross climber
- Mountain trek pathway panel
- Feature flag and roof

Technical Spec

DETAILS

-  6 - 14 years
-  1.5m - 1.8m
-  63.3m²
-  32.12m
-  3.945m

Layout Plan

OVERHEAD

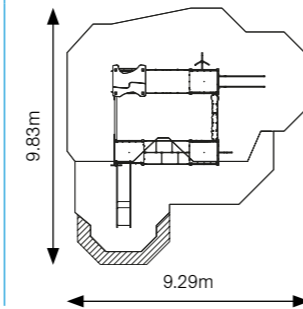

Peak

MNW010



17

PLAY VALUES

- 13 Physical & Locomotor
- 2 Object
- 1 Social
- 1 Role Play & Imaginative

24

USERS





17

PLAY FEATURES

- 1.5m all stainless steel slide
- Stepping stone bridge
- Side to side bridges x2
- Hand over hand
- "V" bridge
- Summit climber
- Zoom pole
- Vertical rungs
- Turnstile climber
- Switchback climbing wall
- Seat under tower
- Step / traverse net
- Binocular / graphic panel
- Searcher panel (at ground level)
- Cross climber
- Mountain trek pathway panel and feature flag

Technical Spec

DETAILS

-  6 - 14 years
-  1.5m - 1.8m
-  62.68m²
-  32.81m
-  3.025m

Layout Plan

OVERHEAD

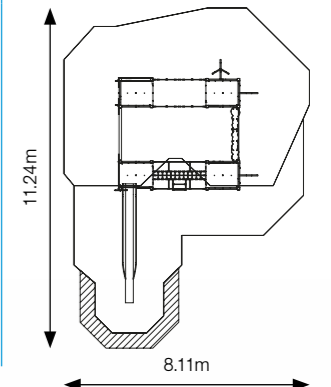

Arete

MNW011

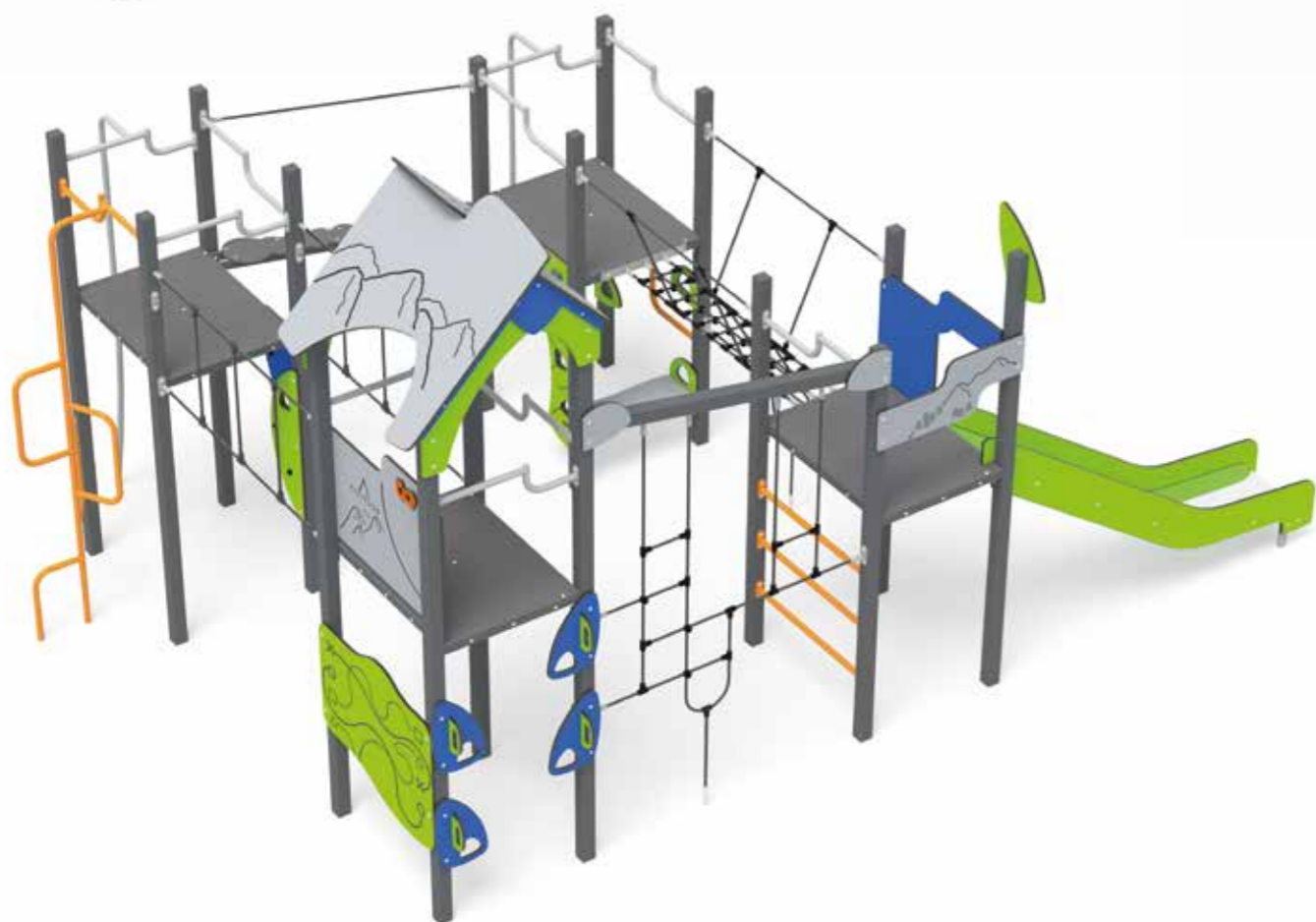

20

PLAY VALUES

- 15 Physical & Locomotor
- 2 Social
- 2 Object
- 1 Role Play & Imaginative

27

USERS





20

PLAY FEATURES

- 1.5m stainless steel bedway slide
- Stepping stone bridge
- Side to side bridges x2
- Hand over hand
- 'V' bridge
- Summit climber
- Zoom pole
- Vertical rungs
- Turnstile climber
- Switchback climbing wall
- Seat under tower
- Step / traverse net
- Slide bars (1.8m)
- Binocular / graphic panel
- Searcher panel (at ground level)
- Cross climber
- Mountain trek pathway panel
- Feature flag and roof

Technical Spec

DETAILS

-  6 - 14 years
-  1.5m - 1.8m
-  58.82m²
-  32.62m
-  3.945m

Layout Plan

OVERHEAD

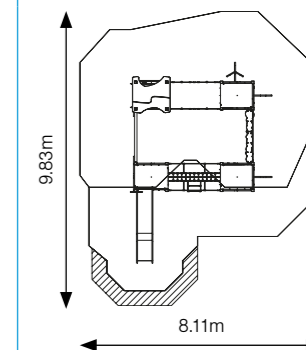

Play Features



1.5m HDPE Slide

A 30 degree slide with a stainless steel bedway and high vertical sides.

PLAY FEATURES

Sliding



1.5m All Stainless Steel Slide

A more traditional profile and a slightly shallower angle (28 degrees).

PLAY FEATURES

Sliding

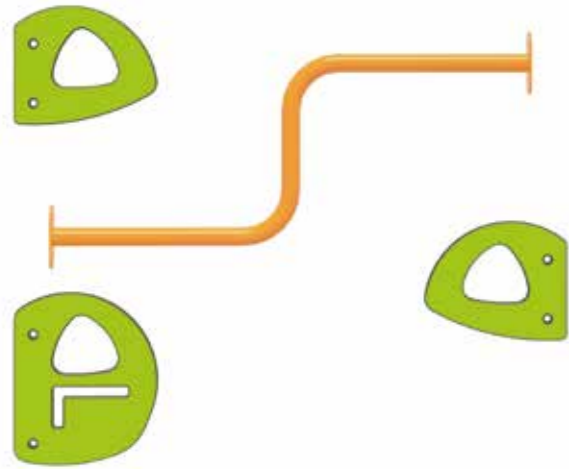

Summit Climber

A unique combination of stepped rungs and hand/fooholds. Users must decide on a sequence of climbing to reach the deck.

PLAY FEATURES

Vertical climbing, balance, hand/foot/eye coordination, cognitive input, strength



Switchback Climbing Wall

A vertical climber which utilises a range of climbing methods. Two types of hand/foot holds and climbing nodules require adjustment of grip and strategy to climb effectively.

PLAY FEATURES

Vertical climbing, strength, hand/foot/eye coordination, cognitive input

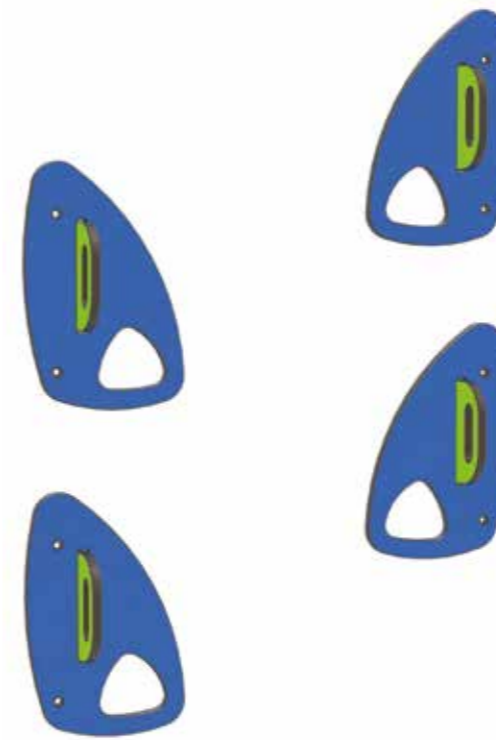

Cross Climber

A combination of foot holds and hand grabs which enable the user to rise vertically with a left right path.

PLAY FEATURES

Vertical climber, hand/foot/eye coordination, strength



Binocular/Graphic Panel

A barrier with 'mountain' routed graphics and a set of 'binoculars' to peep through.

PLAY FEATURES

Imaginative

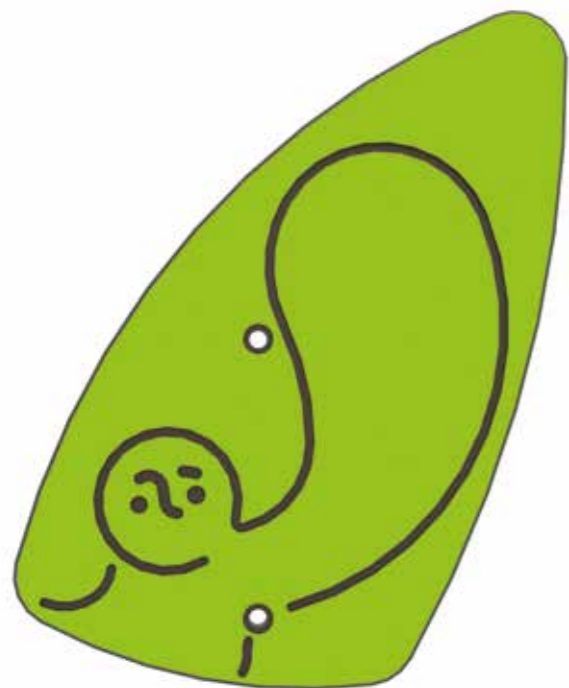

Feature Flag

A graphic flag which can be used as a start/finishing point as users travel around the unit.

PLAY FEATURES

Chasing games

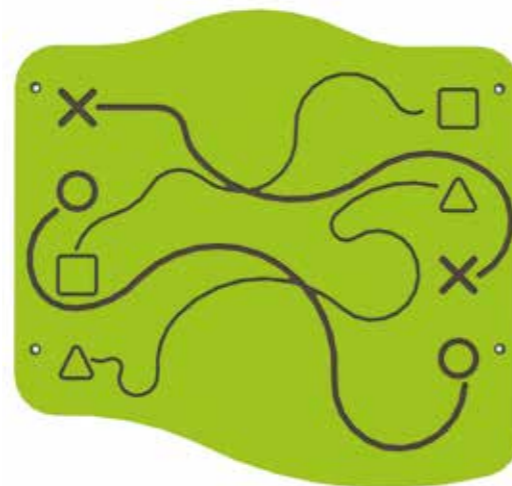

Searcher Panel (at ground level)

A panel with a pathway & shape finder on one side and a routed mountain vista on the other.

PLAY FEATURES

Intellectual, hand/eye coordination



Roof

A signature pitched roof with graphics inside and out. Offers a degree of protection from the elements and signals a natural meeting place for a number of users.

PLAY FEATURES

Social meeting point

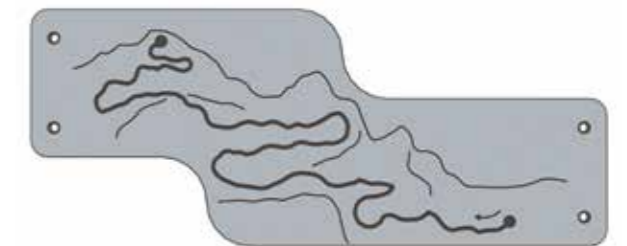

Mountain Trek Pathway Panel

A simple barrier with a finger pathway from base camp to summit.

PLAY FEATURES

Hand/eye coordination



Seat Under Tower

A seat for at least two users with a degree of shelter from the deck above. Also some shelter from the climbing panels at either side.

PLAY FEATURES

Social meeting place, shelter

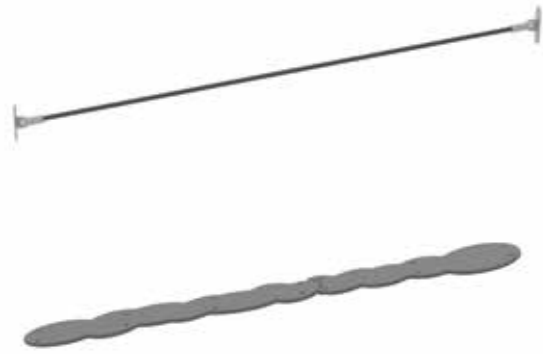

Stepping Stone Bridge

A challenging bridge requiring balance and coordination. Users progress one foot in front of the other with a rope as a hand hold.

PLAY FEATURES

Challenging, balance, hand/foot/eye coordination



'V' Bridge

A classic flexible rope bridge with a multi rope centre to offer a wider space for feet. Two rope rails aid balance while traversing.

PLAY FEATURES

Balance, hand/foot/eye coordination, traversing



Side to Side Bridges (Hand Over Hand Function)

A pair of traversing bridges which can be used individually or as a pair. A degree of coordination is required to sidle along from deck to deck. Users can also grip the rope loops under the bridges as a flexible hand over hand.

PLAY FEATURES

Challenging, balance, hand/foot/eye coordination, strength, traversing



'V' Bridge with Ladder

A classic flexible rope bridge with a multi rope centre to offer a wider space for feet. Two rope rails aid balance while traversing. An additional rope bridge enables side entry from ground level up to the centre of the bridge.

PLAY FEATURES

Balance, hand/foot/eye coordination, traversing, climbing

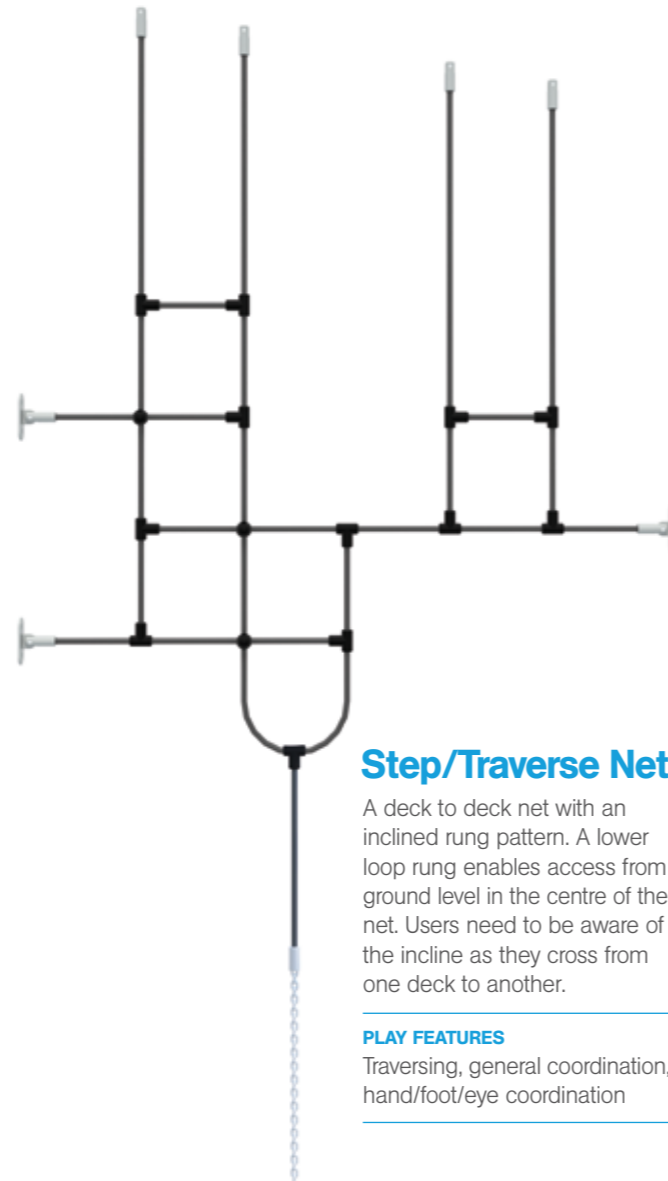

Step/Traverse Net

A deck to deck net with an inclined rung pattern. A lower loop rung enables access from ground level in the centre of the net. Users need to be aware of the incline as they cross from one deck to another.

PLAY FEATURES

Traversing, general coordination, hand/foot/eye coordination



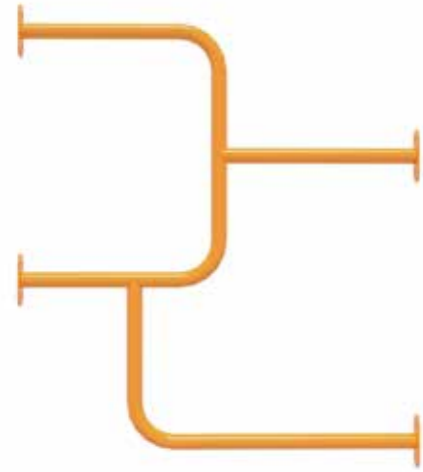

Staggered Rungs

A variation on the vertical ladder but with staggered rungs for a quick climb, requiring left right coordination.

PLAY FEATURES

Vertical climber, hand/foot/eye coordination, strength



Turnstile Climber

A climber which requires the user to follow a circular path, deciding on the next rung as they alter position.

PLAY FEATURES

Vertical climbing with changes in direction, strength, hand/foot/eye coordination, cognitive input

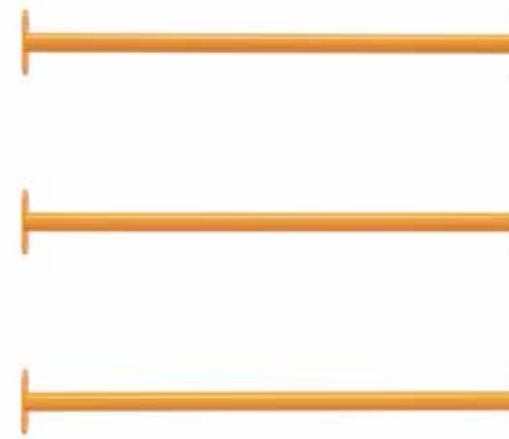
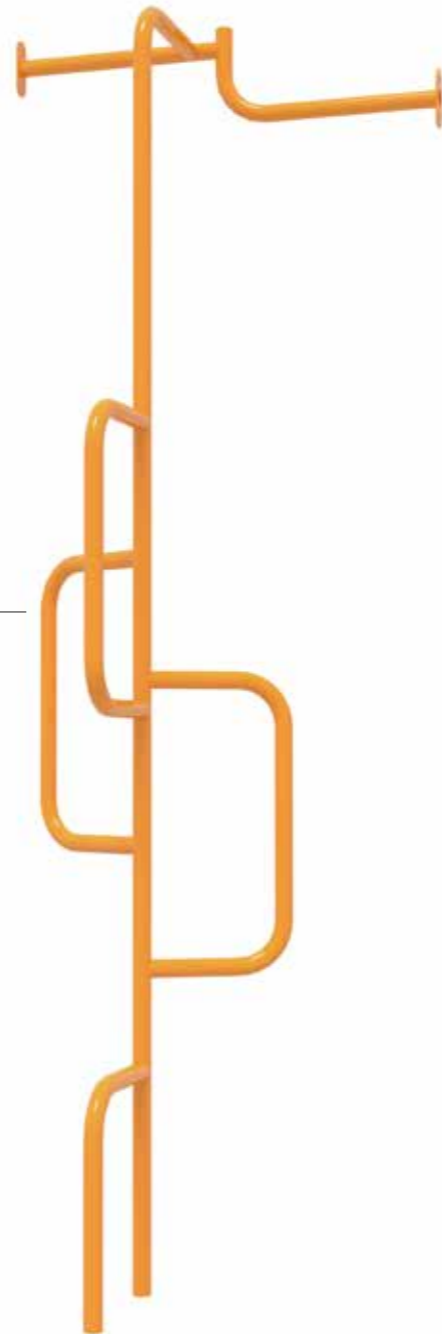

Vertical Rungs

A simple ascent / descent between levels.

PLAY FEATURES

Vertical climbing, strength & general coordination



Slide Bars (1.8m)

A slide which requires a user to straddle two steeply inclined bars to return back to ground level.

PLAY FEATURES

Sliding, balance & coordination

Zoom Pole

A playful way to return to ground level from an upper deck. Requires hands and legs to grip simultaneously to control descent.

PLAY FEATURES

Vertical slider, hand/leg coordination



Standalone Units



Overhead Rotator

TZA030

Technical Spec

DETAILS

- 10+ years
- 2m
- 67.5m²
- 30m
- 3.4m

Layout Plan

OVERHEAD

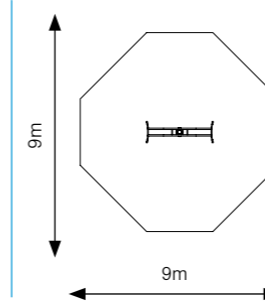

Big Sky Swing

TCS000 With Belt Seats

3 USERS

Technical Spec

DETAILS

- 1 - 15 years
- 1.5m
- 34.63m²
- 21.43m
- 2.86m

Layout Plan

OVERHEAD

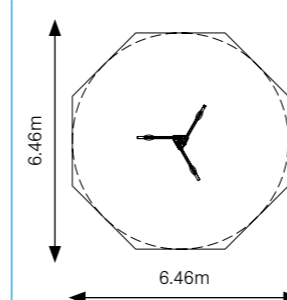

Lifting Gear required for installation.







Rock Spinner

SWD300

Technical Spec

DETAILS

-  8 - 14 years
-  1m
-  20m²
-  12.4m
-  1.37m

Layout Plan

OVERHEAD

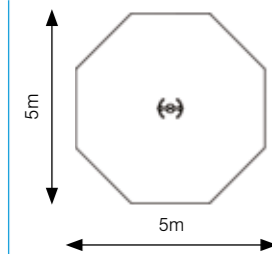

Wipe Out

SWD450

Technical Spec

DETAILS

-  8+ years
-  0.5m
-  10m²
-  11m
-  0.5m

Layout Plan

OVERHEAD

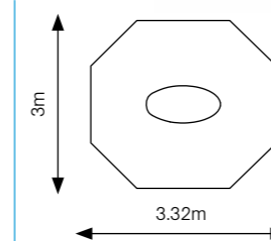





Quad Flyer

SWD350

Technical Spec

DETAILS

-  8+ years
-  1m
-  23.8m²
-  17.8m
-  2.5m

Layout Plan

OVERHEAD

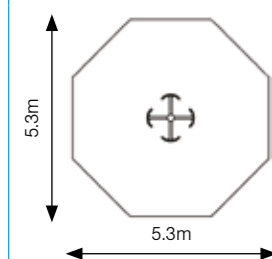





Stand Up Seesaw

TNB050

Technical Spec

DETAILS

-  8 - 14 years
-  1.2m
-  17.9m²
-  17.1m
-  1.6m

Layout Plan

OVERHEAD

