



6-98



2



0,6m



1 = 2,34m
2 = 2,3m
3 = 0,68m



Physical inclusion
Sensory inclusion
Cognitive inclusion

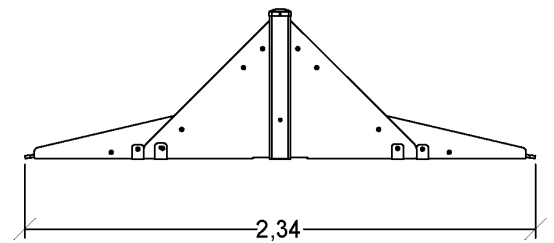
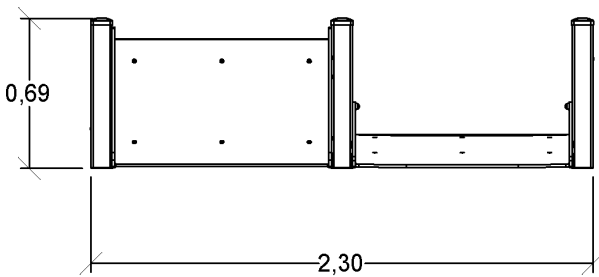
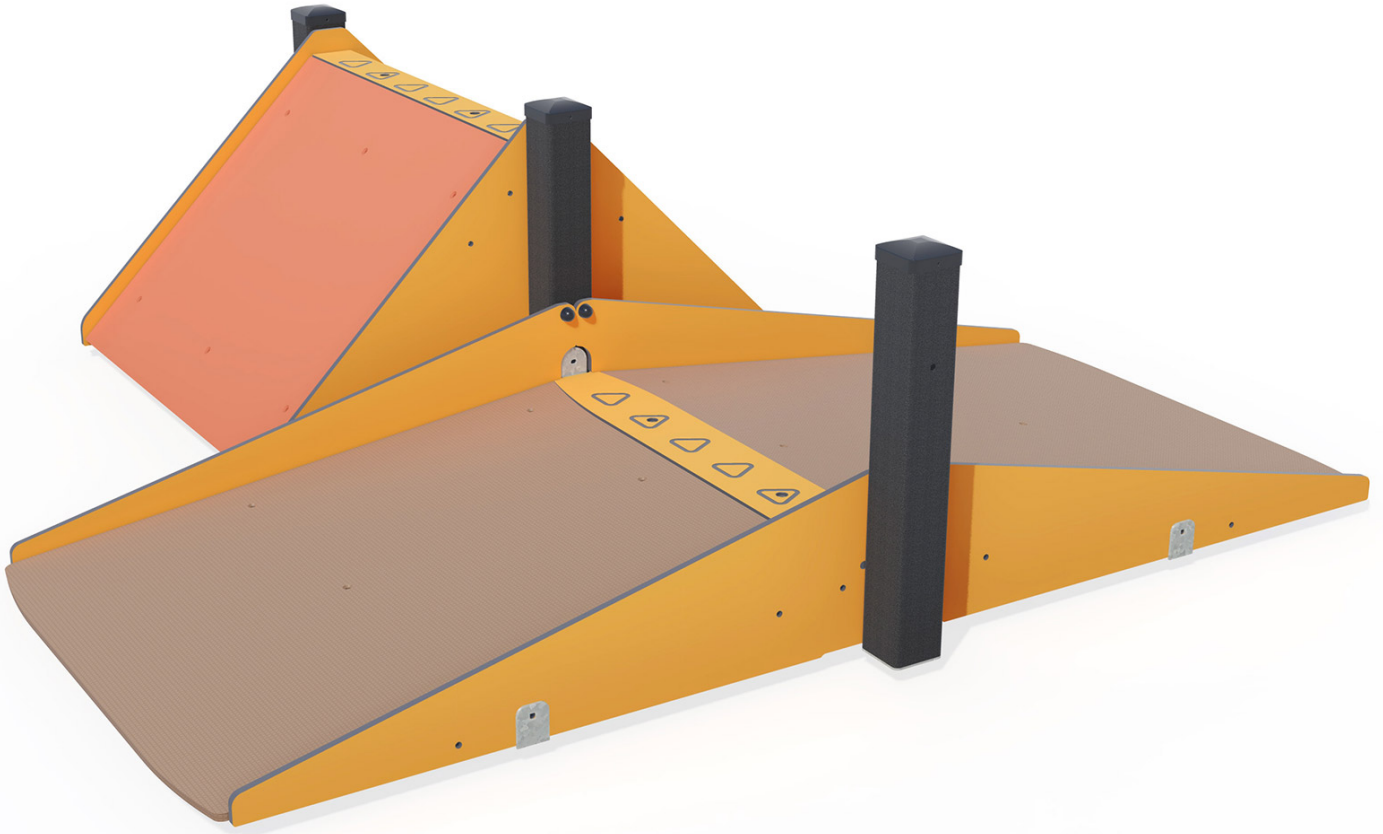
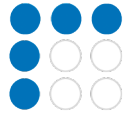

Play value : 2

getting across



x1



climbing





x1

Installation of equipment

IMPORTANT: It is essential to refer to the installation instructions for information on the size of the safety areas.

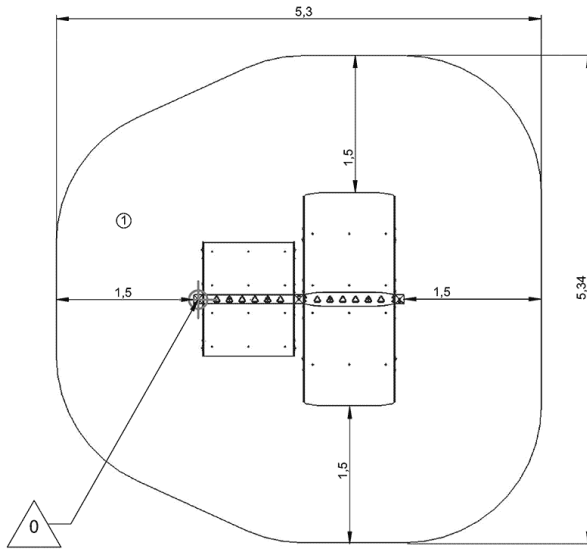
-  Impact area (minimum normative surface)
-  Free space



		
1	<0,6m	24,5m ²



2



02h00



0.19m³



24.5m²



153kg



18kg

EN
1176

Environmental Indicators

Repairability



9,17 /10

Carbon footprint



3,07 KgCO₂/Kg

Recyclable materials



54,95%

ECO materials: 65%

Recycled materials



52,85%

Bio-sourced materials



13,97%

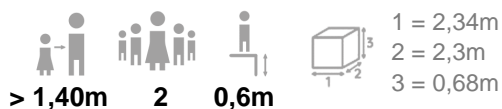

Physical inclusion

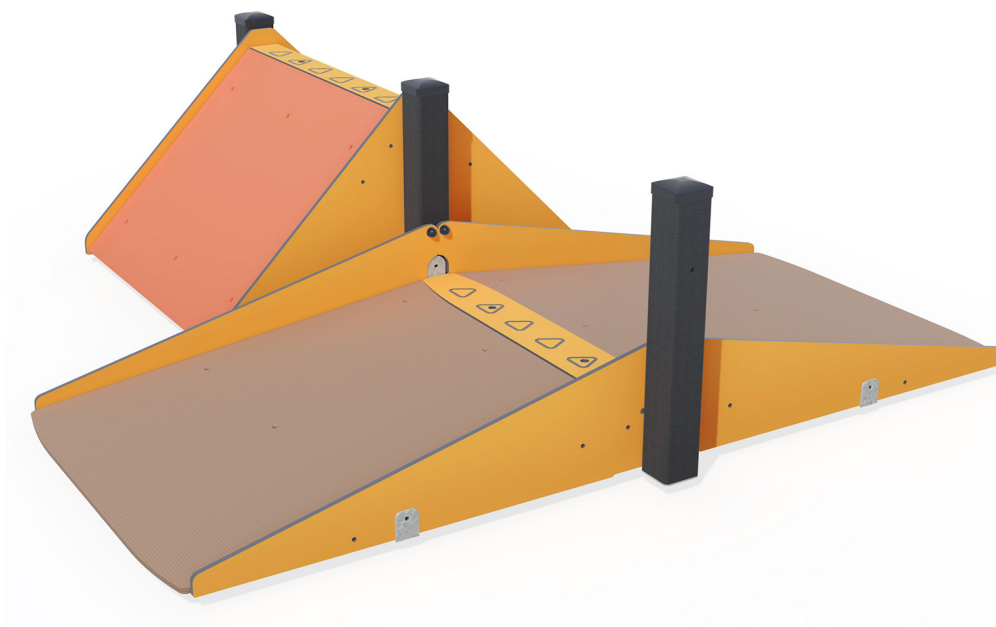

Sports formula

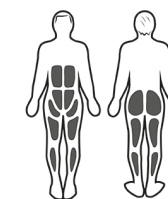

Muscular stimulation

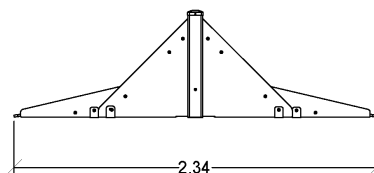
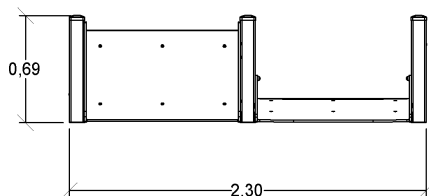

► **Sports activities : 2**

getting across

climbing



► **Recreational sport motivations : 5**



ACTIFUN app



Sensations



Sharing



Diversity



Challenge

muscle strengthening



heart health

balance



coordination

Installation of equipment

IMPORTANT: It is essential to refer to the installation instructions for information on the size of the safety areas.

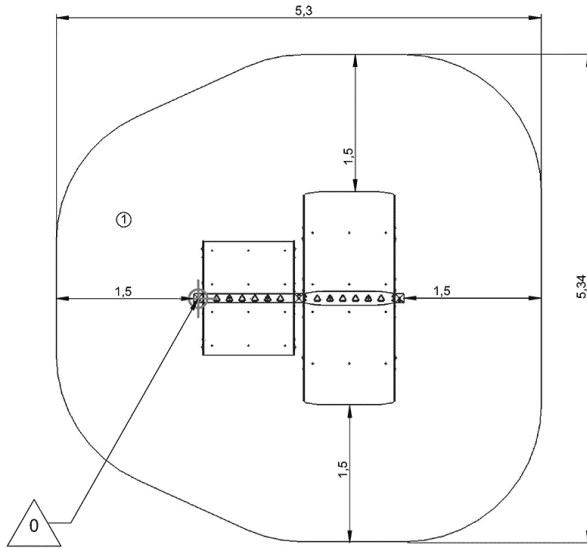
-  Impact area (minimum normative surface)
-  Free space



		
1	<0,6m	24,5m²



2



02h00



0.19m³



24.5m²



153kg



18kg



Environmental Indicators

Repairability



9,17 /10

Carbon footprint



3,07 KgCO₂/Kg

Recyclable materials



54,95%

ECO materials: 65%

Recycled materials



52,85%

Bio-sourced materials



13,97%