

Physical inclusion
Sensory inclusion
Cognitive inclusion

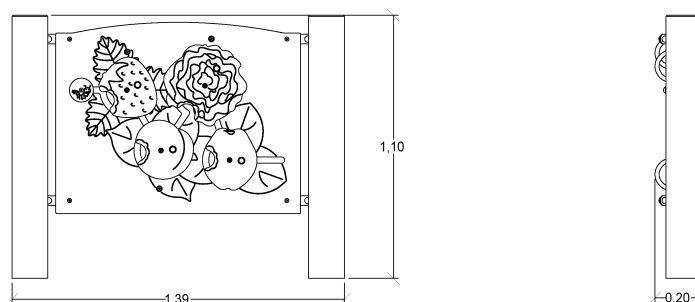

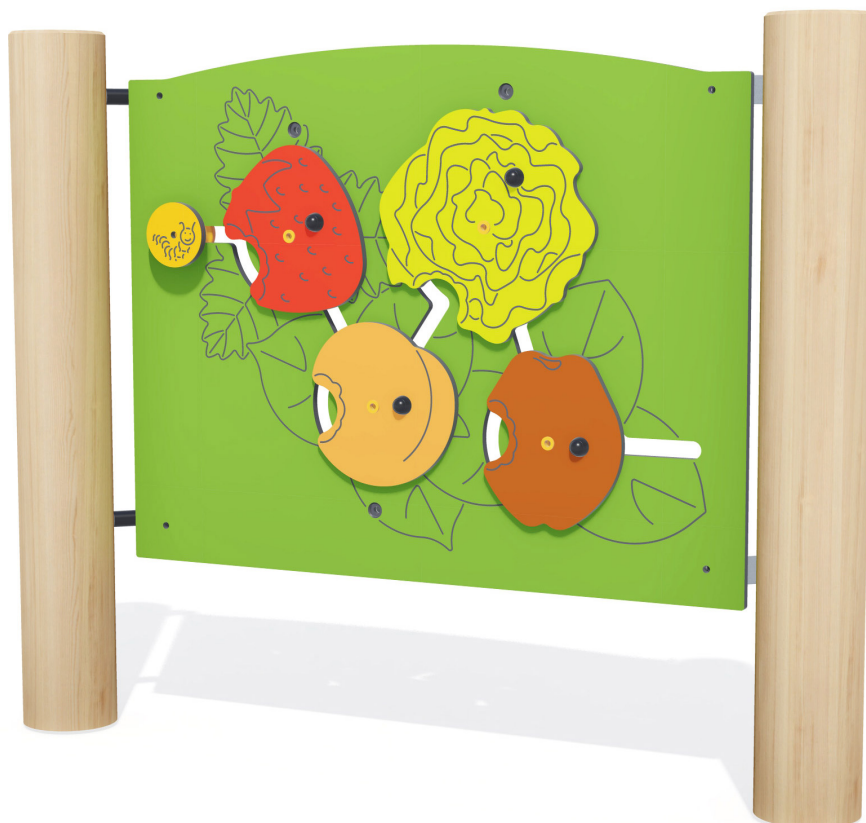

Play value : **8**



role play	meeting	handling	tactile stimulation
x1	x1	x5	x1

Installation of equipment

IMPORTANT: It is essential to refer to the installation instructions for information on the size of the safety areas.

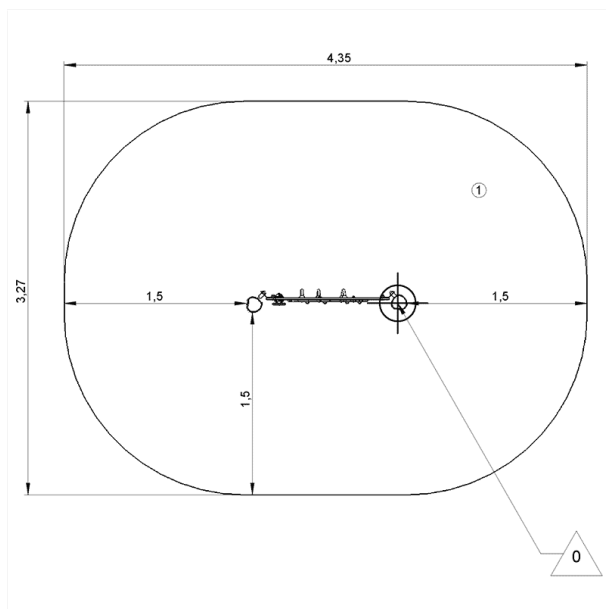
-  Impact area (minimum normative surface)
-  Free space



		
1	<0,6m	12,5m ²



2



01h00



0.13m³



12.5m²



58kg



19kg

EN
1176

Environmental Indicators

Repairability



9,57 /10

Carbon footprint



0,23 KgCO₂/Kg

Recyclable materials



71,38%

ECO materials: 89%

Recycled materials



17,27%

Bio-sourced materials



72,02%