

Muscari Planter

Product Specification

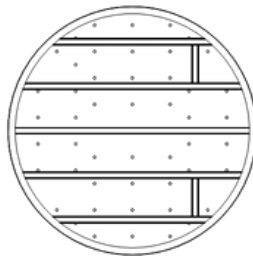

Powder coated galvanised steel

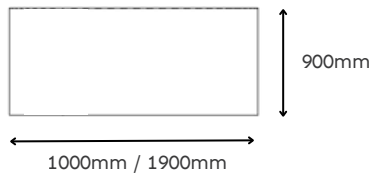
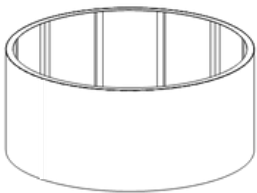

Standard dimensions:
D x H (mm)

MUP01
Ø 1000 x 900

MUP02
Ø 1900 x 900

Steel specification:

- 2mm folded PPC galvanised steel

Mounting options:

- 100mm x 100mm box section feet
- Bolt down

Standard RAL Colour selection:



Case study colour: Interpon D2525





Turning the grey green®

To find out more email enquiries@meristemdesign.co.uk

Muscari Bench

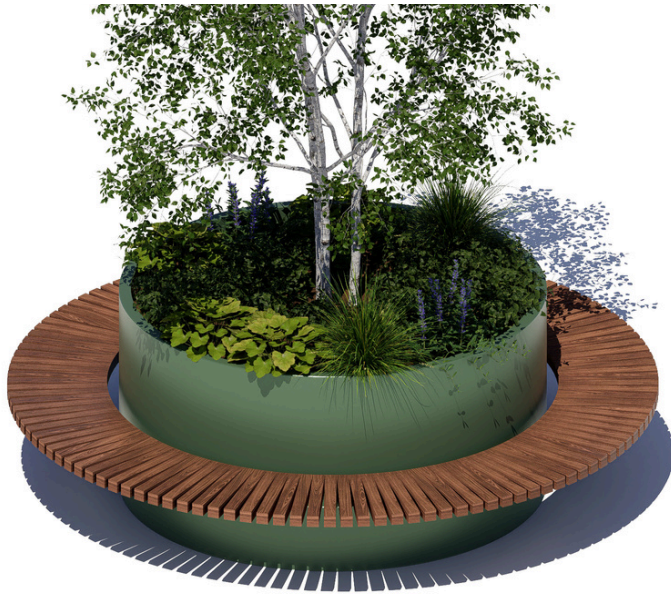
Product Specification



-  Powder coated galvanised steel
-  Sapele hardwood timber

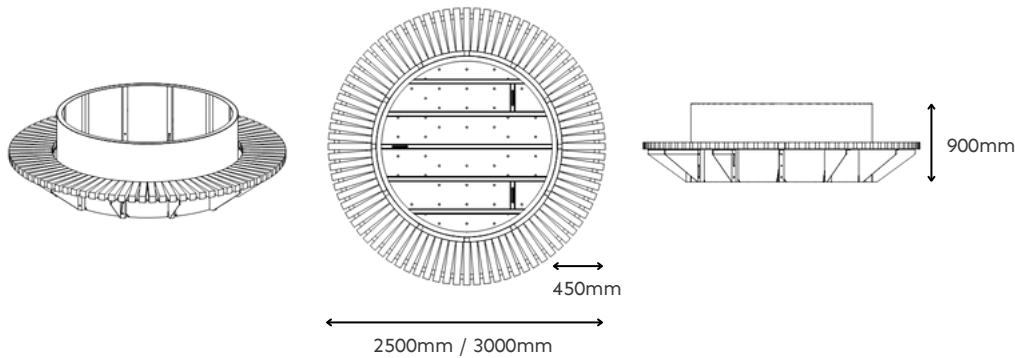

Standard dimensions:
D x H (mm)

MUB01
Ø 2500 x 900

MUB02
Ø 3000 x 900

Steel specification:

- 2mm folded PPC galvanised steel

Timber specification:

- 69mm x 69mm PAR Sapele hardwood slats

Mounting options:

- 100mm x 100mm box section feet
- Bolt down



Case study colours: RAL 7016 Anthracite Grey

Standard RAL Colour selection:



Turning the grey green®

To find out more email enquiries@meristemdesign.co.uk