

 **3+**
 **12**
 **1,89m**



 1 = 9,33m
 2 = 2,4m
 3 = 6,26m





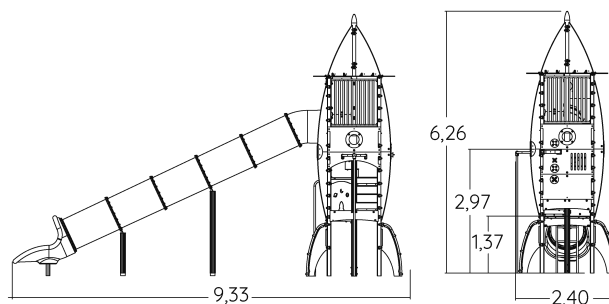
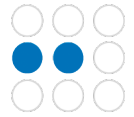



Physical inclusion
 Sensory inclusion
 Cognitive inclusion





Play value :

9

role play	sliding	meeting	taking shelter	visual stimulation	climbing
					
x1	x2	x1	x1	x2	x2

Installation of equipment

IMPORTANT: It is essential to refer to the installation instructions for information on the size of the safety areas.

-  Impact area (minimum normative surface)
-  Free space

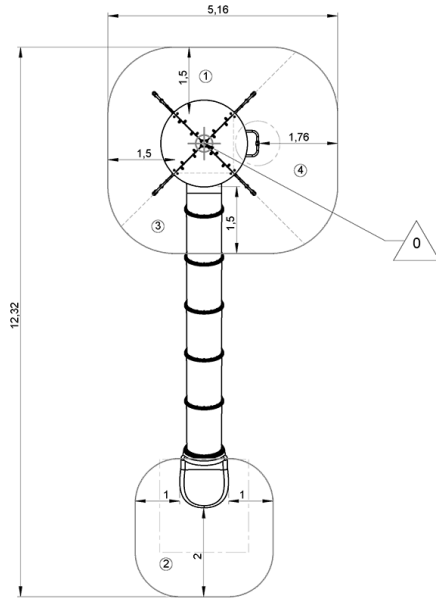

1	0,6m	10m ²
2	1m	9m ²
3	1,37m	5,5m ²
4	1,89m	7,5m ²



2



20h00



2.42m³



32m²



1030kg



41kg

EN
1176