



2+



12



1,64m



1 = 2,24m
2 = 2,11m
3 = 2,74m





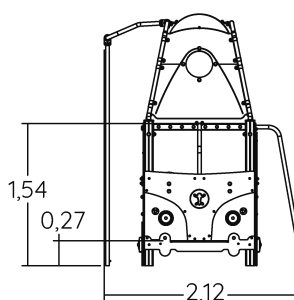
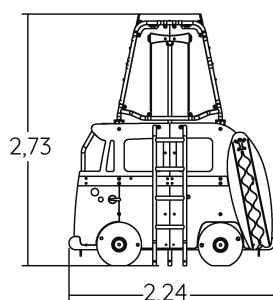







Physical inclusion
Sensory inclusion
Cognitive inclusion



Play value :

19



role play	sliding	meeting	resting	handling	hiding	taking shelter	sound stimulation
							
x1	x1	x1	x4	x2	x1	x1	x1
tactile stimulation	visual stimulation	climbing					
							
x3	x3	x1					

Installation of equipment

IMPORTANT: It is essential to refer to the installation instructions for information on the size of the safety areas.

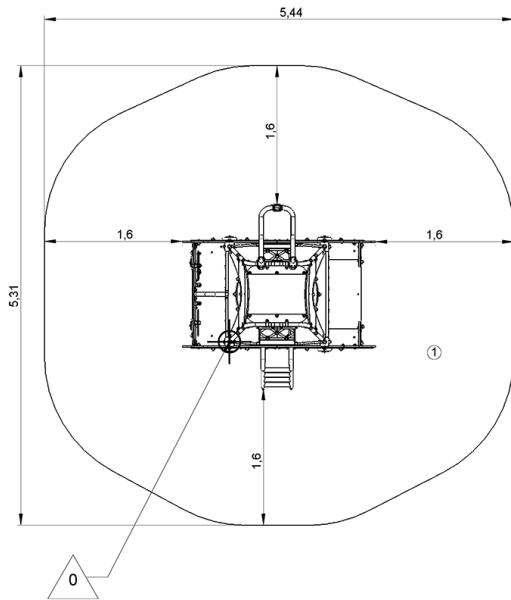
-  Impact area (minimum normative surface)
-  Free space



		
1	1,64m	24,5m ²



2



08h00



0.19m³



24.5m²



444kg



39kg

EN
1176