









 2+
  24
  2,3m
 
 1 = 10,05m
 2 = 6,62m
 3 = 3,34m

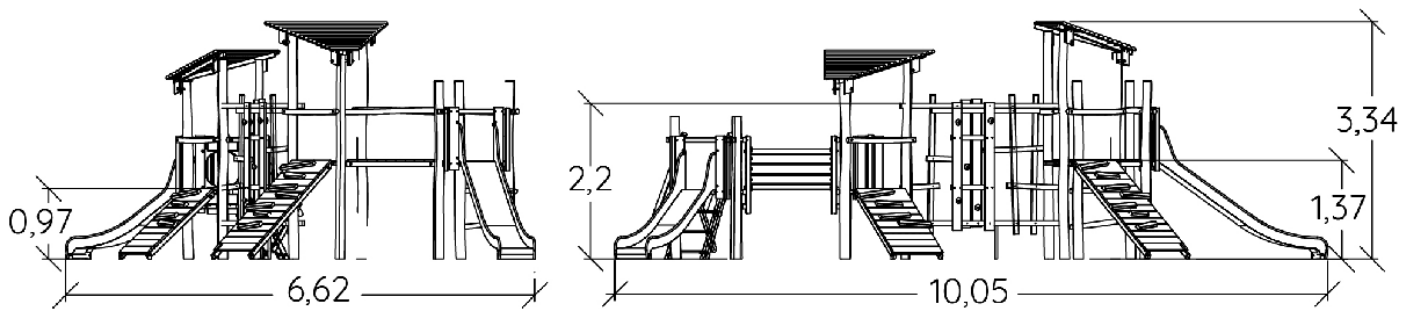

Physical inclusion
Sensory inclusion
Cognitive inclusion



Play value : 20

climbing	role play	sliding	meeting	crawling	hiding	taking shelter	climbing
							
x1	x2	x2	x4	x1	x1	x2	x4

getting across



x3

Components

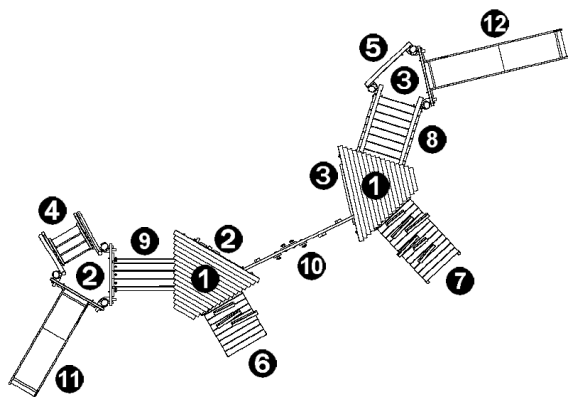

- ❶ Roof
- ❷ Platform Ht: 0.97m
- ❸ Platform Ht: 1.37m
- ❹ Stairs
- ❺ Vertical ladder Ht: 1.17
- ❻ Sloping ramp with logs Ht: 0.97m
- ❼ Sloping ramp with logs Ht: 1.37m
- ❽ Crossover
- ❾ Tunnel
- ❿ Climbing wall
- ⓫ Slide Ht: 0.97m
- ⓬ Slide Ht: 1.37m

Installation of equipment

IMPORTANT: It is essential to refer to the installation instructions for information on the size of the safety areas.

- Impact area (minimum normative surface)
- Free space

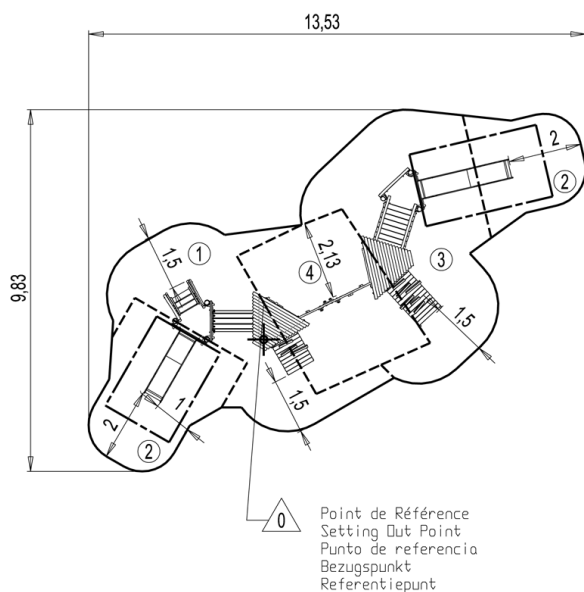

1	0,97m	16,5m ²
2	1m	19,5m ²
3	1,37m	22,5m ²
4	2,3m	14,5m ²



3



20h00



0.13m³



73m²



1093kg



57kg

EN
1176