









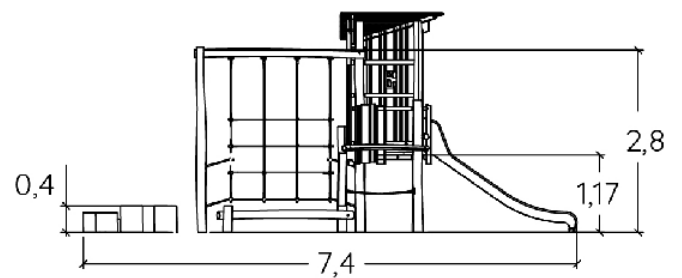
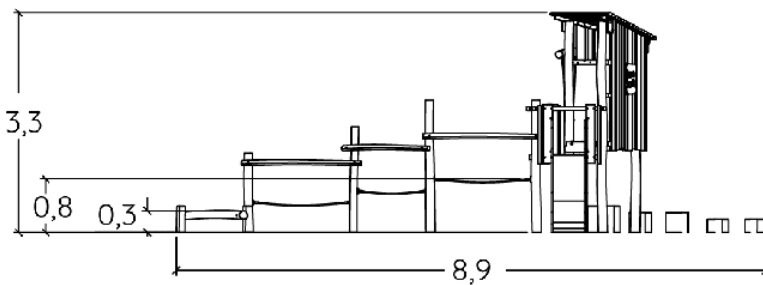

 **3+**
 **17**
 **1,7m**

 1 = 7,4m
 2 = 8,9m
 3 = 3,3m



Physical inclusion
Sensory inclusion
Cognitive inclusion

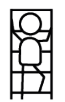

Play value : 15

role play	sliding	meeting	jumping	balancing	taking shelter	visual stimulation	climbing
							
x1	x1	x2	x1	x3	x1	x1	x1
getting across							
							
x4							

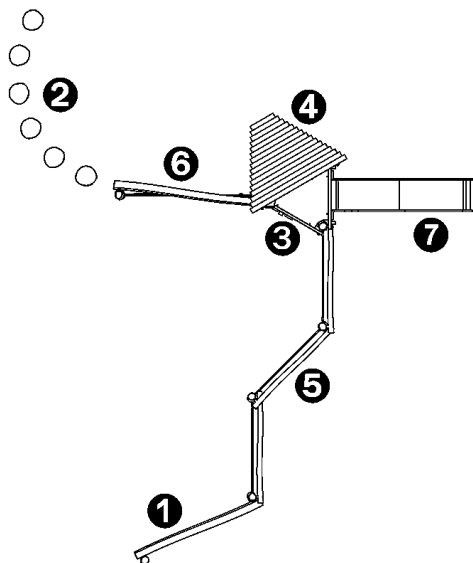

Components



- ❶ Balance Beam
- ❷ Japanese steps
- ❸ Roof
- ❹ Platform Ht: 1.37m
- ❺ Rope walkway
- ❻ Vertical net
- ❼ Slide Ht: 1.17m

Installation of equipment

IMPORTANT: It is essential to refer to the installation instructions for information on the size of the safety areas.

-  Impact area (minimum normative surface)
-  Free space

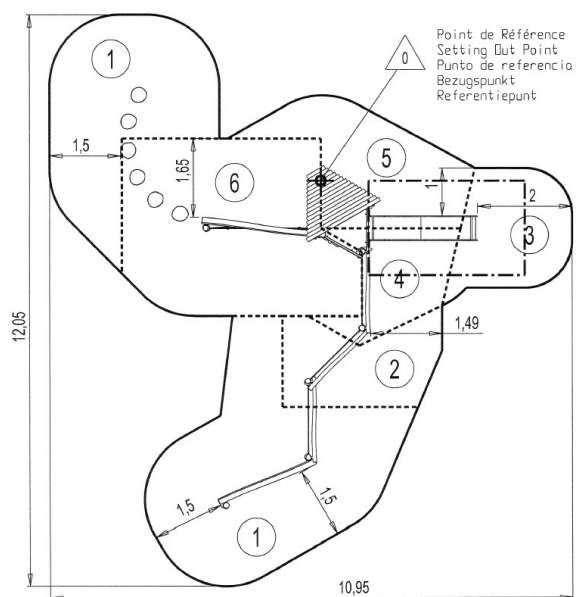

1	0,6m	29m ²
2	0,86m	5,5m ²
3	1m	5,6m ²
4	1,17m	4,5m ²
5	1,37m	8m ²
6	1,7m	16,5m ²



2

9h50

0.39m³

69.5m²

872kg

250kg

EN
1176