

 **2+**
 **12**
 **1m**







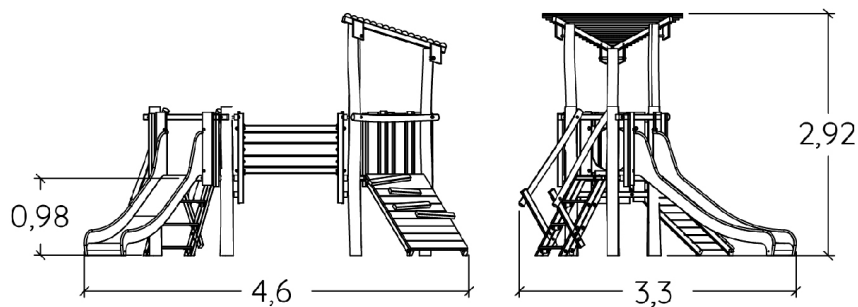

 1 = 3,3m
 2 = 4,6m
 3 = 2,92m



Physical inclusion
Sensory inclusion
Cognitive inclusion



Play value : **10**

role play	sliding	meeting	crawling	hiding	taking shelter	climbing	getting across
							
x1	x1	x2	x1	x1	x1	x2	x1

Components

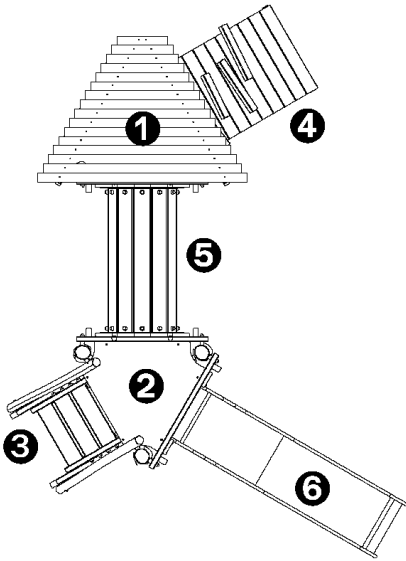

- 1 Roof
- 2 Platform Ht: 0.97m
- 3 Stairs
- 4 Sloping ramp with logs Ht: 0.97m
- 5 Green tunnel
- 6 Slide Ht: 0.97m

Installation of equipment

IMPORTANT: It is essential to refer to the installation instructions for information on the size of the safety areas.

- Impact area (minimum normative surface)
- Free space

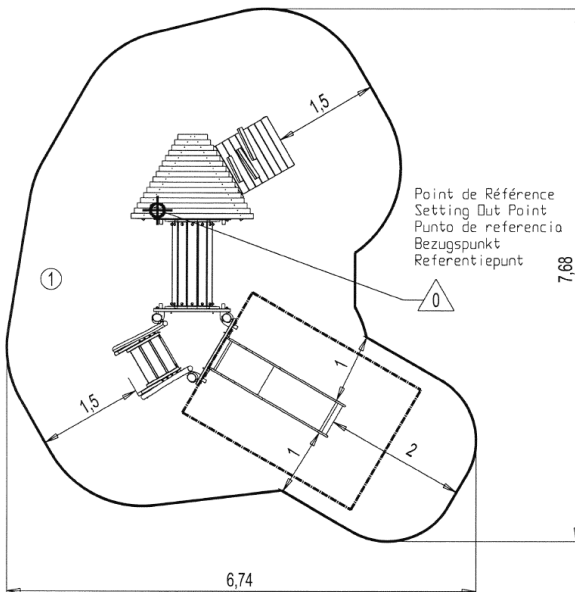

1	1m
	36m ²



2



12h00



0m³



36m²



543kg



53kg

EN
1176