

 2+
 1
 0,6m

 1 = 0,79m
 2 = 0,44m
 3 = 0,72m



Physical inclusion
Sensory inclusion
Cognitive inclusion

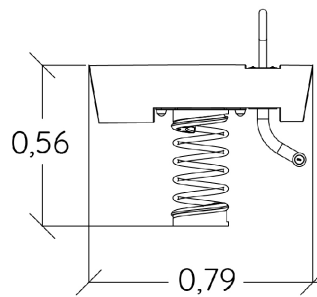
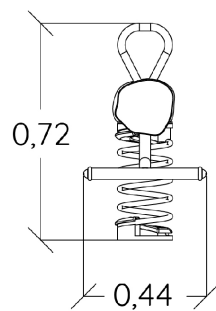
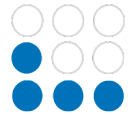

Play value : 3

role play

balancing

Oscillate



x1



x1





x1

Installation of equipment

IMPORTANT: It is essential to refer to the installation instructions for information on the size of the safety areas.

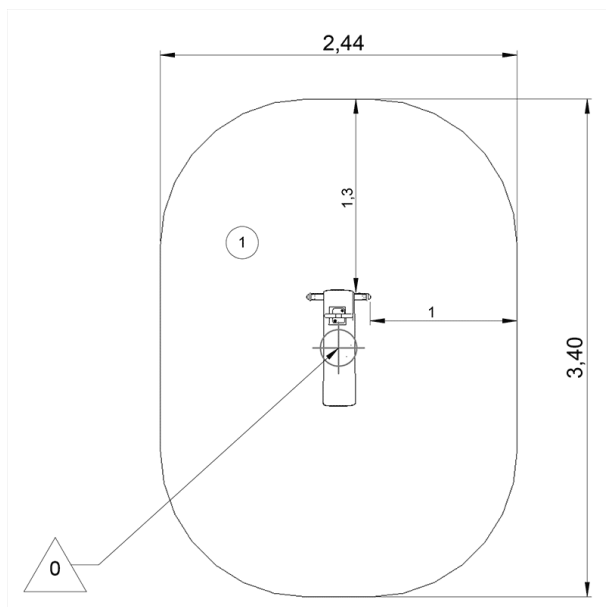
-  Impact area (minimum normative surface)
-  Free space



		
1	0,60m	7,5m ²



2



02h15



0.02m³



7.5m²



39kg



19kg

EN
1176