

Sports formula

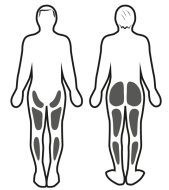

Muscular stimulation

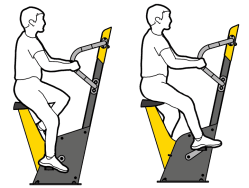

Movements

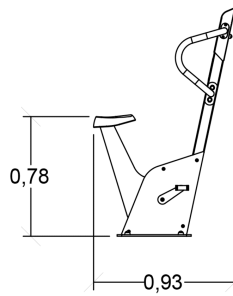
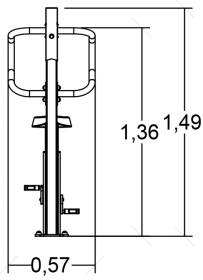

► **Sports activities :** **1**

pedalling



muscle strengthening



heart health

balance



coordination

► Installation of equipment

IMPORTANT: It is essential to refer to the installation instructions for information on the size of the safety areas.

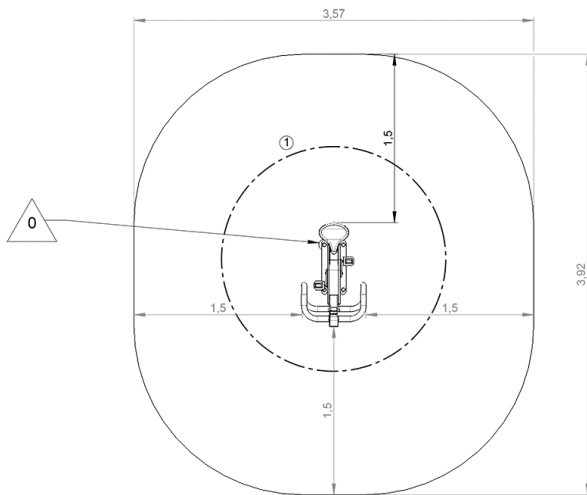
-  Impact area (minimum normative surface)
-  Free space



		
1	0,78m	12,08m ²



2



02h00



0m³



12.5m²



54kg



47kg

