









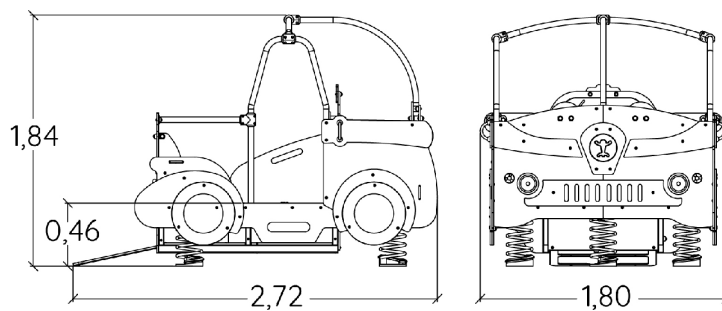

 2+
  8
  0,6m
 
 1 = 2,72m  
 2 = 1,8m  
 3 = 1,84m



Physical inclusion  
Sensory inclusion  
Cognitive inclusion



**Play value :** 16



| role play   | meeting   | resting   | handling  | sound stimulation   | tactile stimulation  | visual stimulation  | Oscillate   |
|---|---|---|---|---|--|---|---|
|  |  |  |  |  |  |  |  |
| x1  | x1  | x2  | x4  | x1  | x5   | x1  | x1  |

## Installation of equipment

**IMPORTANT:** It is essential to refer to the installation instructions for information on the size of the safety areas.

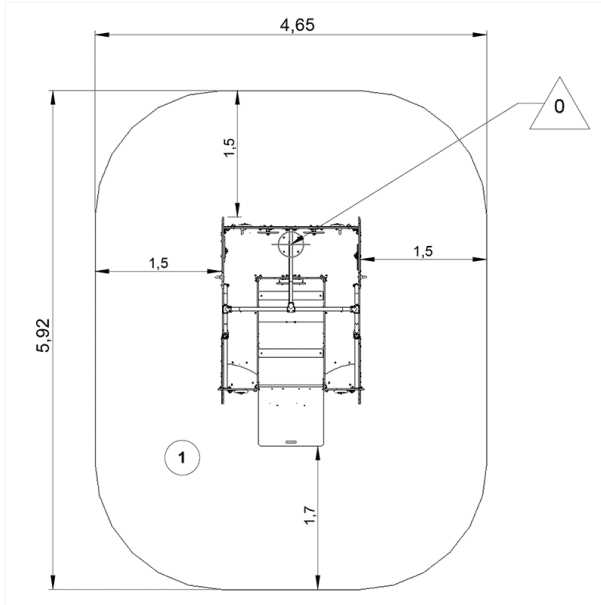
-  Impact area (minimum normative surface)
-  Free space



|   |   |   |
|---|---|---|
|   |  |  |
| 1 | 0,6m  | 26m <sup>2</sup>  |



2



04h00



0m<sup>3</sup>



26m<sup>2</sup>



396kg



50kg

EN  
1176