



2-8



1



0,6m



1 = 0,58m
2 = 0,4m
3 = 0,84m



Physical inclusion
Sensory inclusion
Cognitive inclusion

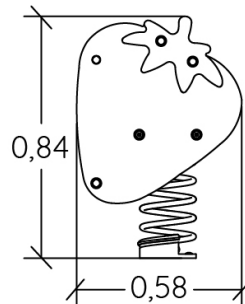
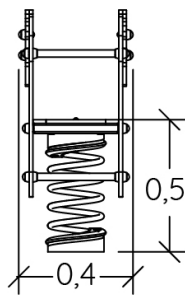
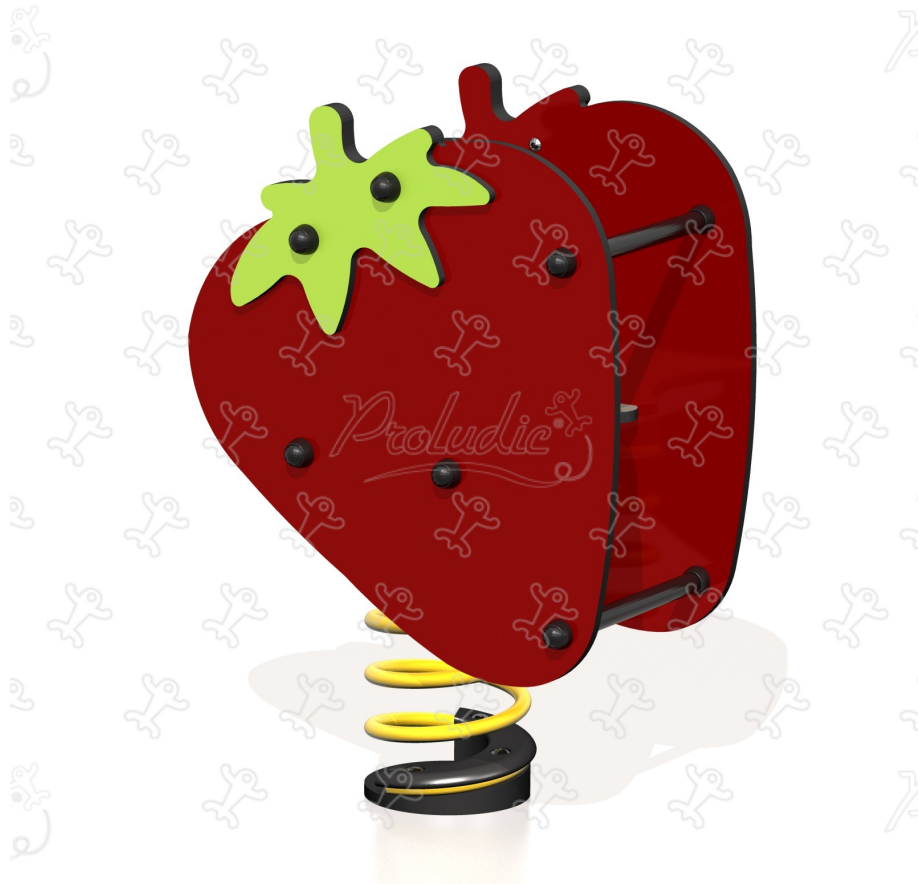
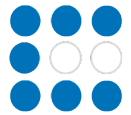

Play value :

3

role play



x1

balancing



x1

Oscillate





x1

Installation of equipment

IMPORTANT: It is essential to refer to the installation instructions for information on the size of the safety areas.

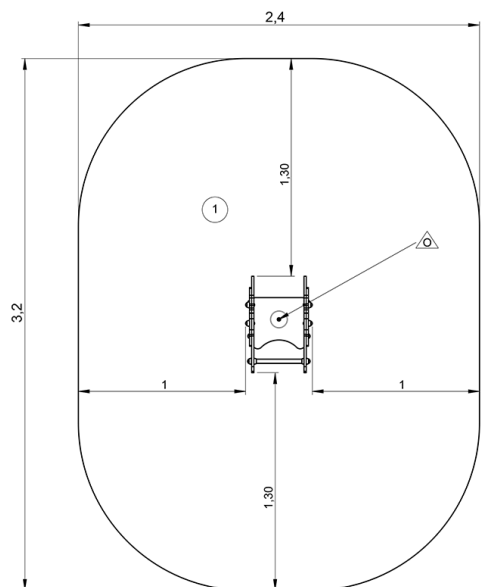
-  Impact area (minimum normative surface)
-  Free space



		
1	0,6m	7m ²



1



01h00



0m³



7m²



32kg



11kg

EN
1176