

 **2+**  
 **10**  
 **0,6m**







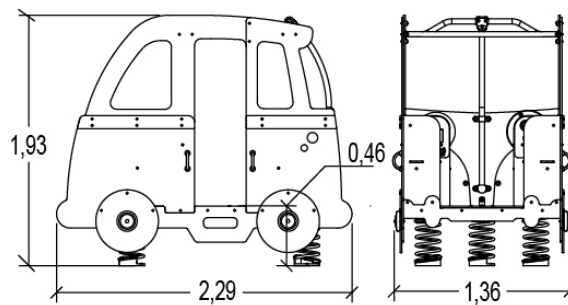
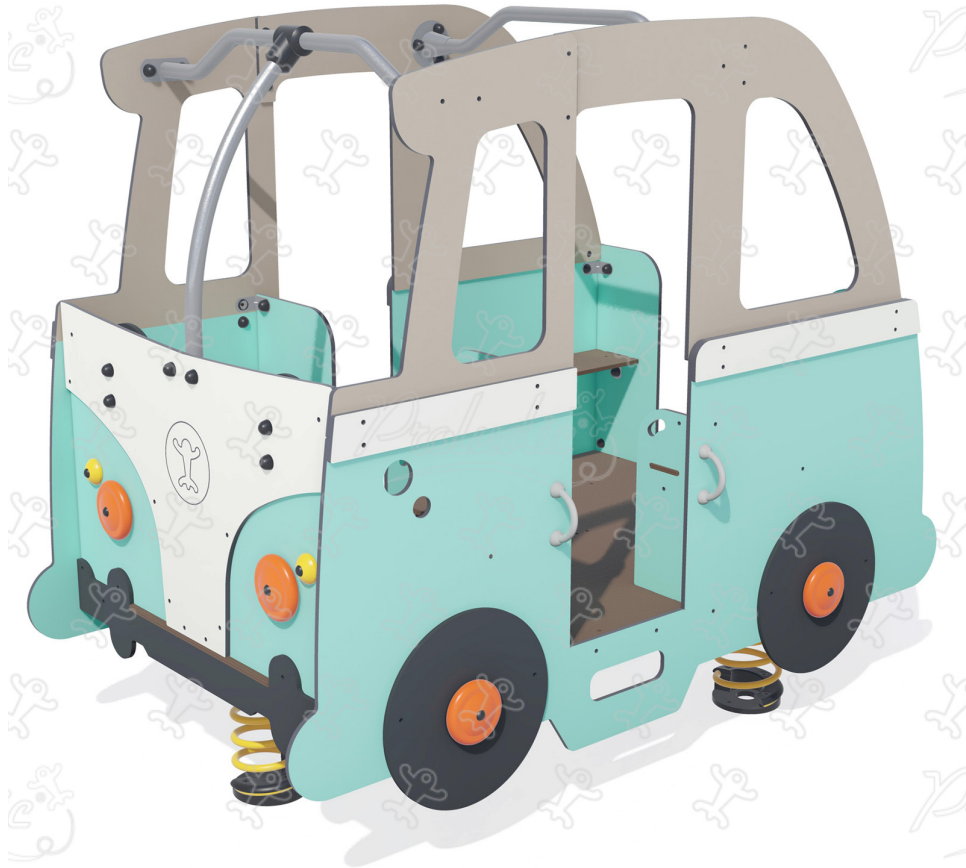

  
 1 = 2,29m  
 2 = 1,36m  
 3 = 1,93m



Physical inclusion  
Sensory inclusion  
Cognitive inclusion



**Play value :** **10**



role play	meeting	resting	handling	balancing	thinking	tactile stimulation	Oscillate
							
<b>x1</b>	<b>x1</b>	<b>x1</b>	<b>x2</b>	<b>x1</b>	<b>x1</b>	<b>x2</b>	<b>x1</b>

## Installation of equipment

**IMPORTANT:** It is essential to refer to the installation instructions for information on the size of the safety areas.

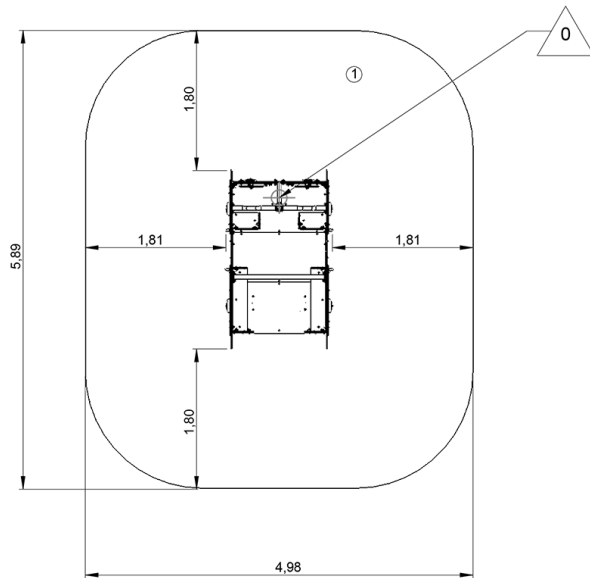
-  Impact area (minimum normative surface)
-  Free space



		
1	0,6m	27,5m <sup>2</sup>



2



5h00



0m<sup>3</sup>



27.5m<sup>2</sup>



300kg



13kg

EN  
1176