

 3+
  10
  0m





 1 = 2,26m  
 2 = 1,26m  
 3 = 0,82m

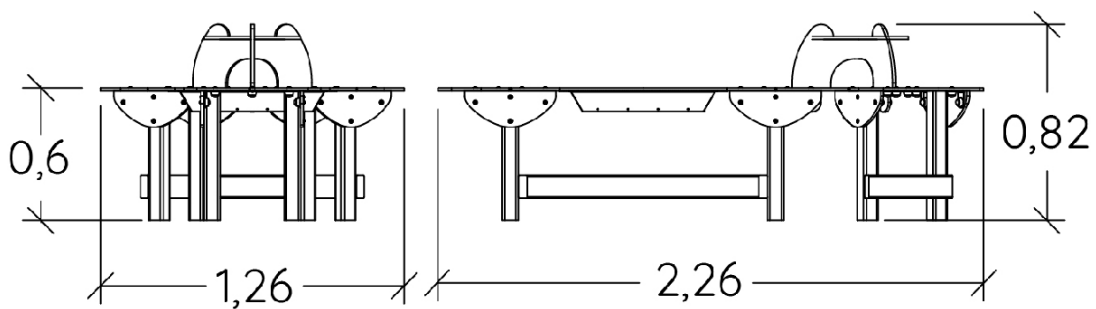

Physical inclusion  
Sensory inclusion  
Cognitive inclusion



**Play value :** 6

meeting	resting	handling	tactile stimulation
			
x1	x1	x2	x2

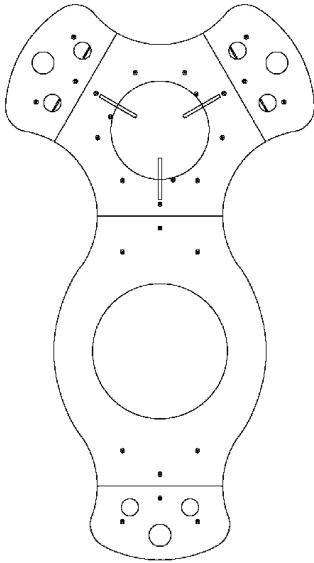

## Components





- ❶ ETAGERE
- ❷ ILOT D EXPO
- ❸ SUPPORT PLOTS
- ❹ PIED HT 550
- ❺ BAC

## Installation of equipment

**IMPORTANT:** It is essential to refer to the installation instructions for information on the size of the safety areas.

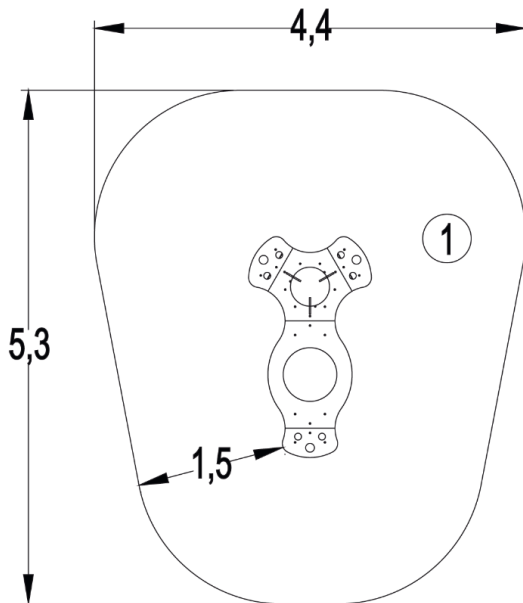
-  Impact area (minimum normative surface)
-  Free space



		
1	0m	20,5m <sup>2</sup>



2



4h00



0.22m<sup>3</sup>



20.5m<sup>2</sup>



76kg



9kg

EN  
1176