



3+



4



0,6m



1 = 2,2m
2 = 1,16m
3 = 1,2m



Physical inclusion
Sensory inclusion
Cognitive inclusion

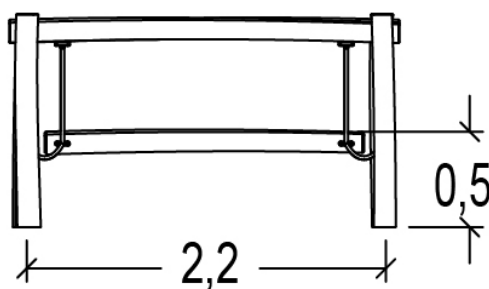
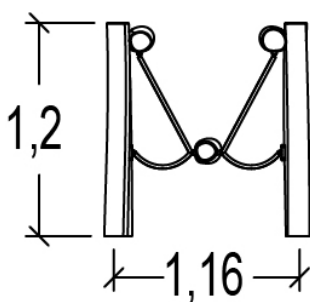
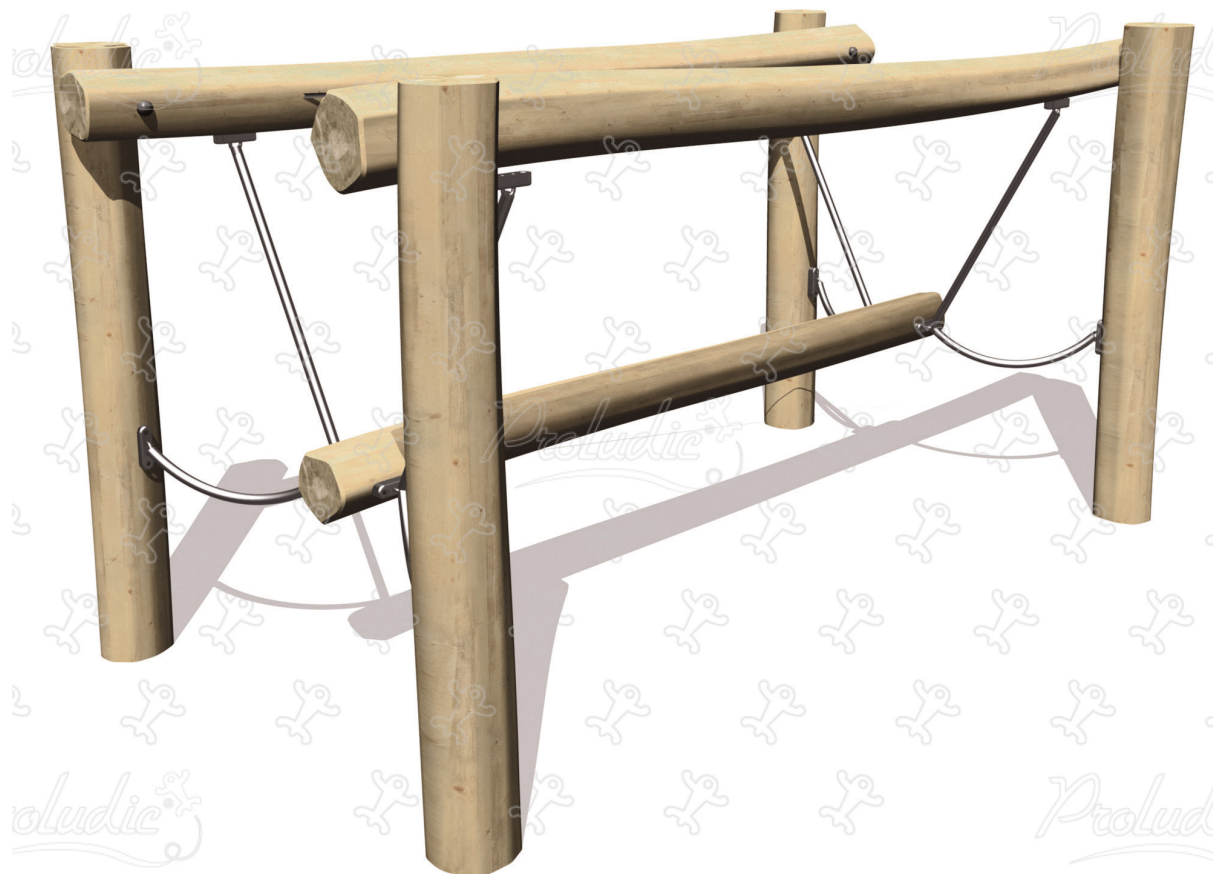

Play value : **3**

meeting



x1

balancing



x1

getting across



x1



Components

① Suspended beam





Installation of equipment

IMPORTANT: It is essential to refer to the installation instructions for information on the size of the safety areas.

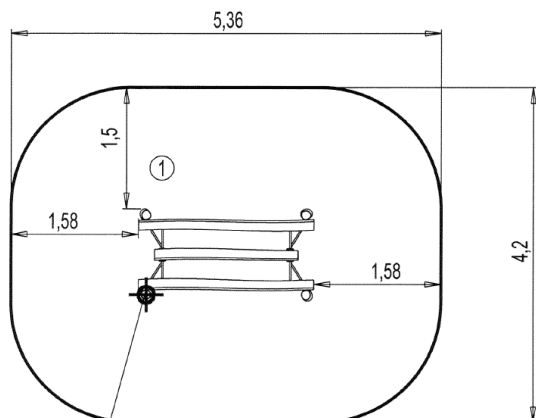
-  Impact area (minimum normative surface)
-  Free space



Point de Référence
Setting Out Point
Punto de referencia
Bezugspunkt
Referentiepunt

		
1	<0,6m	21m ²



2



01h00



0m³



21m²



138kg



20kg

EN
1176