

 **2+**
 **42**
 **1m**









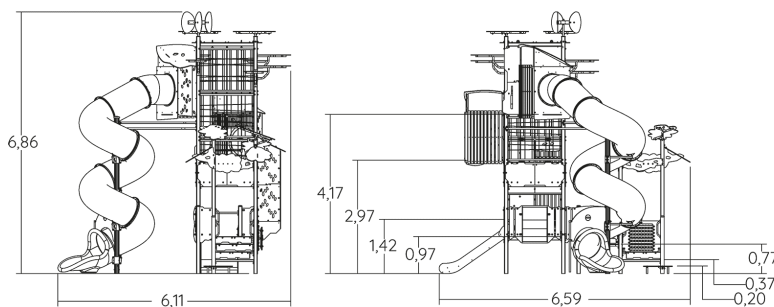





 1 = 6,62m
 2 = 6,12m
 3 = 6,86m



Physical inclusion
 Sensory inclusion
 Cognitive inclusion



Play value : **42**

climbing  x1	role play  x5	sliding  x2	meeting  x4	resting  x1	handling  x5	hiding  x3	balancing  x1
taking shelter  x4	thinking  x2	tactile stimulation  x5	visual stimulation  x5	climbing  x3	getting across  x1		

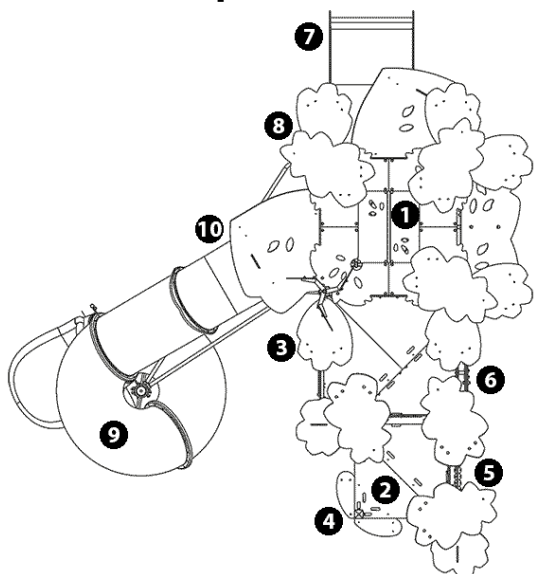

Components



- ① Tour 6m - passage déporté
- ② Plate-forme transfert Ht : 0.97 m
- ③ Panneau ludique sensoriel
- ④ Escalier transfert
- ⑤ Panneau ludique boulier
- ⑥ Panneau disques/labyrinthe
- ⑦ Toboggan Ht : 0.97 m
- ⑧ Panneau miroir déformant
- ⑨ Polyéthylène slide Ht : 4.17m
- ⑩ Play porthole

Installation of equipment

IMPORTANT: It is essential to refer to the installation instructions for information on the size of the safety areas.

-  Impact area (minimum normative surface)
-  Free space

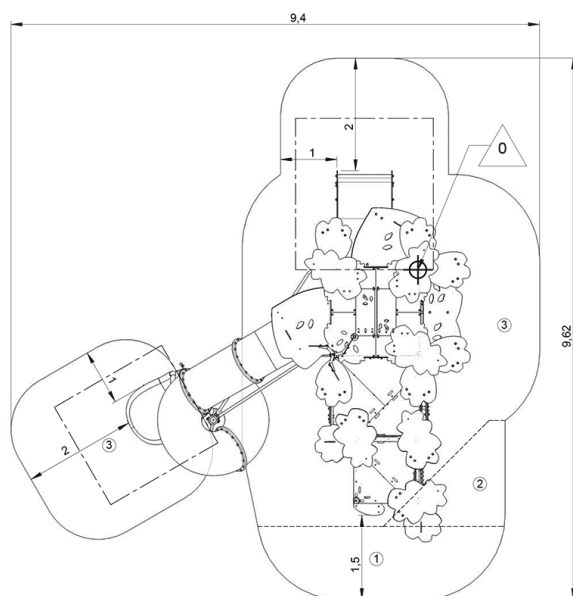

1	0,6m	5m ²
2	0,77m	2,5m ²
3	1m	43,5m ²



3



20h00



1.2m³



51m²



2375kg



72kg

EN
1176