

 **2+**
 **4**
 **0,5m**







 1 = 2,09m
 2 = 1,76m
 3 = 2,96m

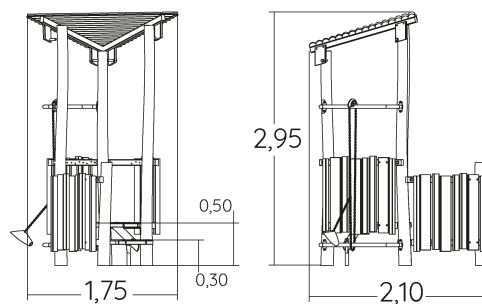

Physical inclusion
 Sensory inclusion
 Cognitive inclusion



Play value : **9**

role play	meeting	handling	hiding	taking shelter	tactile stimulation	climbing
						
x1	x1	x2	x1	x1	x2	x1

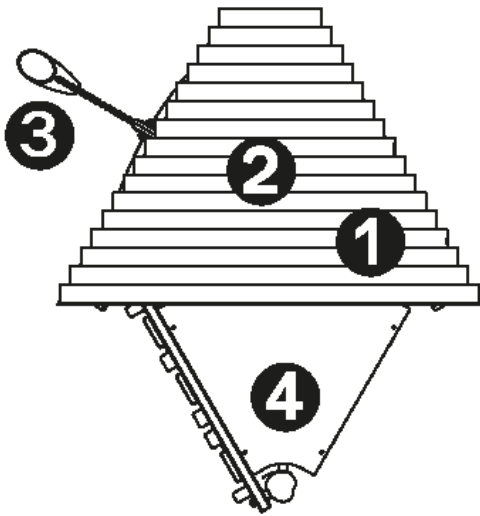

Components





- ① Platform
- ② Roof
- ③ Grue h 1.57m
- ④ Plate-forme h 0.5m

Installation of equipment

IMPORTANT: It is essential to refer to the installation instructions for information on the size of the safety areas.

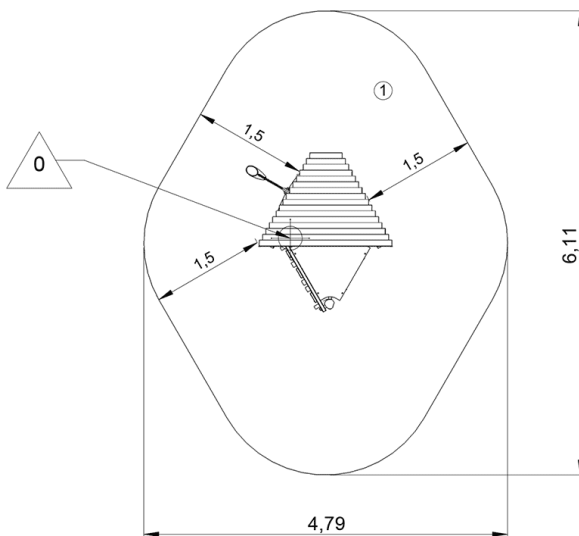
-  Impact area (minimum normative surface)
-  Free space



		
1	0,5m	21m ²



3



08h00



0.29m³



21m²



301kg



38kg

EN
1176