



3+



1



0,6m



1 = 1,93m
2 = 1,32m
3 = 1,6m



Physical inclusion
Sensory inclusion
Cognitive inclusion

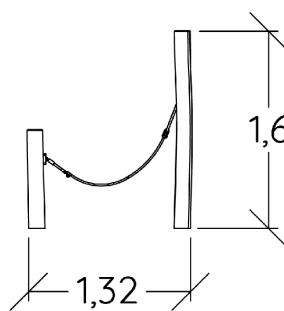
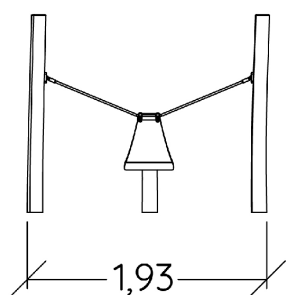

Play value : **1**

resting



x1

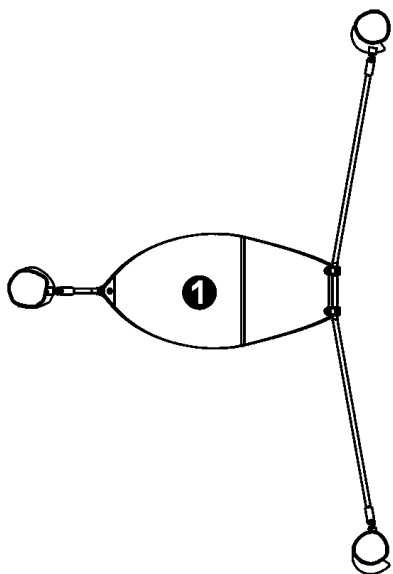

Components





1 Hammock

Installation of equipment

IMPORTANT: It is essential to refer to the installation instructions for information on the size of the safety areas.

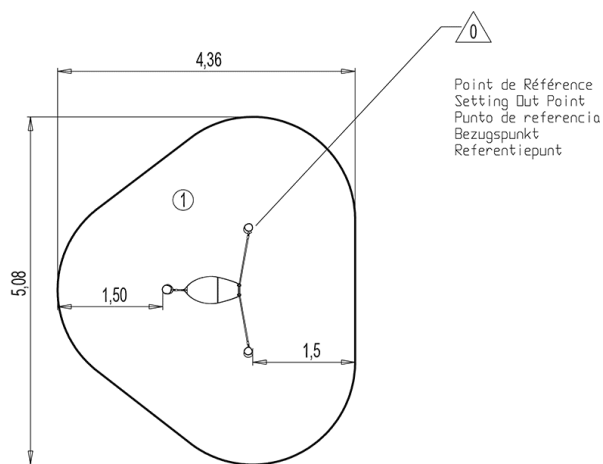
-  Impact area (minimum normative surface)
-  Free space



		
1	<0,6m	17m ²



2



01h00



0.2m³



17m²



72kg



25kg

EN
1176