









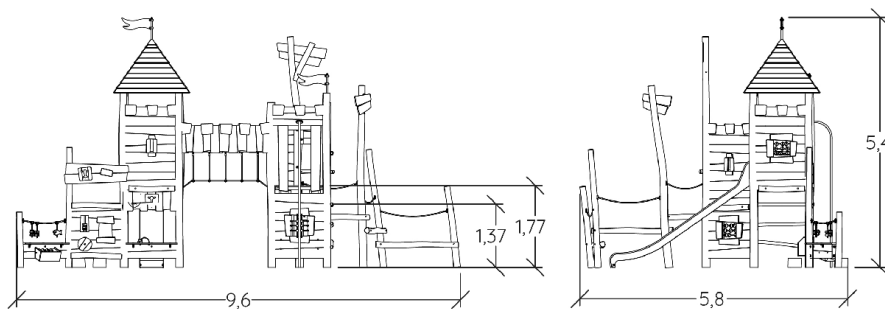

 **2+**
 **30**
 **2,17m**

 1 = 9,6m
 2 = 5,8m
 3 = 5,4m



Physical inclusion
Sensory inclusion
Cognitive inclusion





Play value : 33



role play	sliding	meeting	resting	handling	balancing	tactile stimulation	visual stimulation
							
x1	x2	x3	x3	x7	x2	x7	x4
climbing	getting across						
							
x2	x2						

Installation of equipment

IMPORTANT: It is essential to refer to the installation instructions for information on the size of the safety areas.

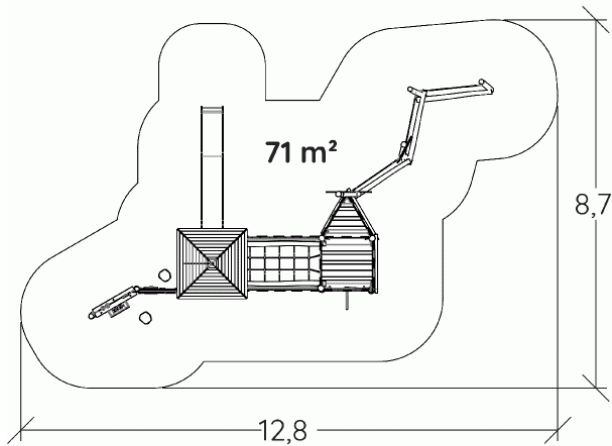
-  Impact area (minimum normative surface)
-  Free space



		
1	<0,6m	8,5m ²
2	0,9m	8m ²
3	1m	4,5m ²
4	1,1m	7m ²
5	1,37m	3,5m ²
6	1,5m	7m ²
7	1,77m	28,5m ²
8	2,17m	9,5m ²



0



0.32m³



76.5m²



1729kg



1624kg

EN
1176