

design
make
play

SutcliffePlay

Waggon Lane
Upton Pontefract
West Yorkshire WF9 1JS
Telephone +44 (0) 1977 653200
Facsimile +44 (0) 1977 653222
info@sutcliffeplay.co.uk
www.sutcliffeplay.co.uk



Fantasy - Unicorn Installation Instructions Ftw011

Ftw011

Unit Installation Instructions

design
make
play
SutcliffePlay

1. Check using the Parts List that none of the components are missing.
2. Plan the final position of the play equipment ensuring there is sufficient space.
3. Sort and identify parts before assembly.
4. Excavate the foundation holes in accordance with the plan. Ensuring post holes are levelled and chocked in at the bottom of the holes.
5. Position 2 x 300mm long spragging irons into the holes provided in each post upright and stand in the foundation holes.
Do not tighten the fixing bolts until all the activities have been assembled.
6. Assemble the activities onto the posts as per the diagrams in this document. Leave fixing bolts loose until all the activities have been assembled. Ground fixed activities need 200mm spragging irons positioned through their holes.
7. Assemble the slide as per the diagrams in this document.
8. When all activities have been assembled, tighten all the fixings, attach nut covers where necessary, ensure the unit is level and the posts are vertical.
9. Fill the foundation holes to the required depth with concrete.
10. Do not allow the equipment to be used until the concrete has set (2 - 3 days) and the required safety surfacing has been installed.
11. Tighten all fixing bolts.
12. Follow the maintenance instructions supplied.

NB:

1. Slide runouts should be inclined downwards by approximately 2 degrees for drainage purposes.
2. During installation care must be taken to prevent hazards to children.
3. Extra care should be taken if conditions are abnormal.

Ftw011

Unit Parts List

design
make
play
SutcliffePlay

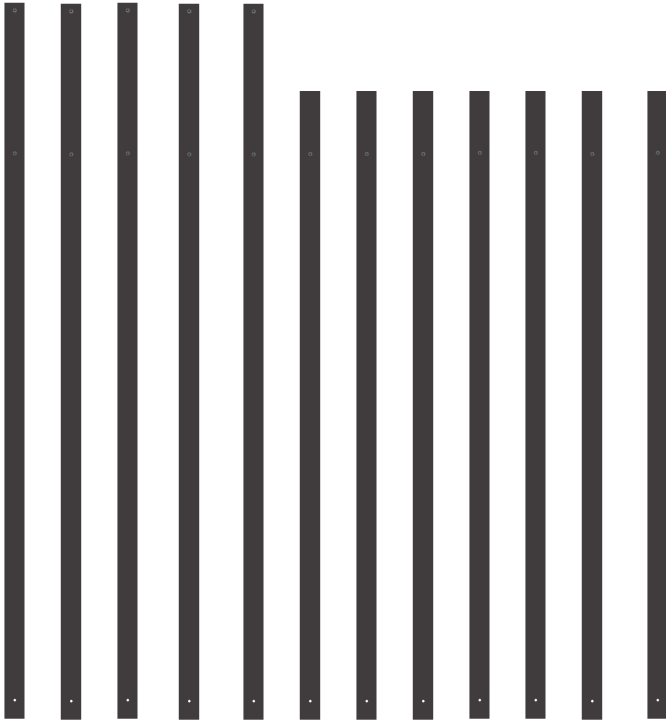

Ftp011 x1
Set of 12 Posts

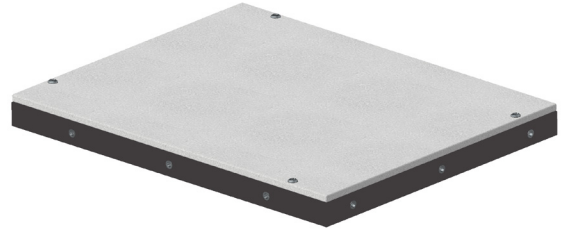

Ftd003 x3

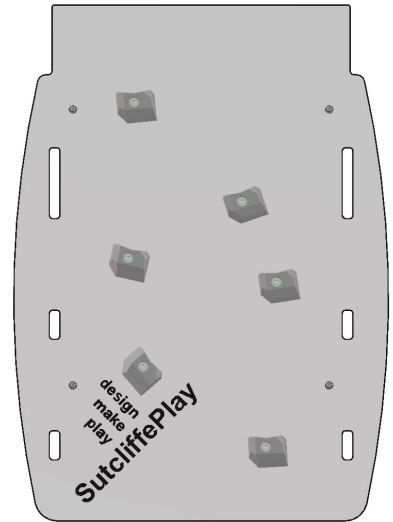

Fta010 x1



Fta009 x2



Fta012 x1



Fta011 x1

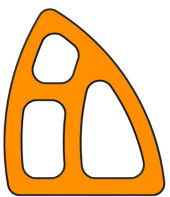

Fta013 x2

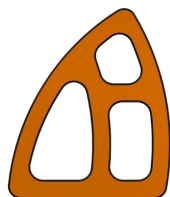

Fta014 x2

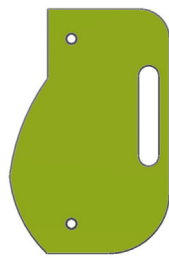

Fta015 x6



Ftw011F x1

Ftw011

Unit Parts List

design
make
play
SutcliffePlay

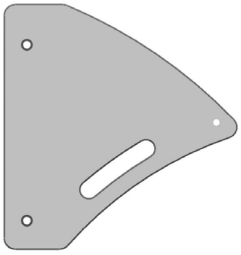

Fta016 x2

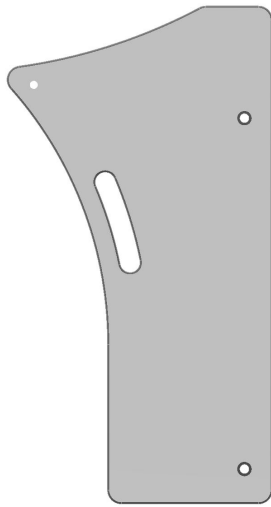

Fta017 x2

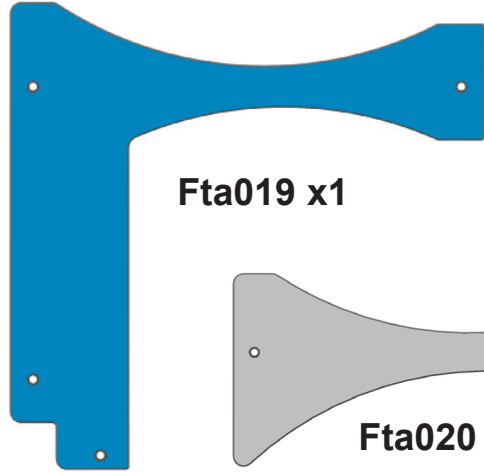

Fta019 x1

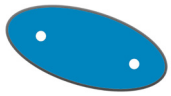

Fta018 x2

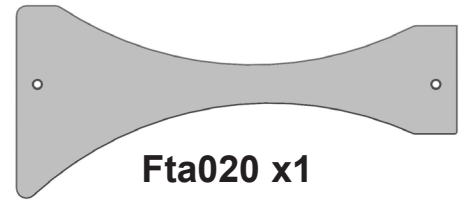

Fta020 x1



Fta021 x1

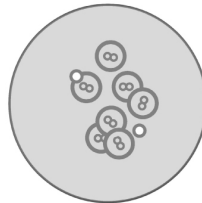

Fta022 x1

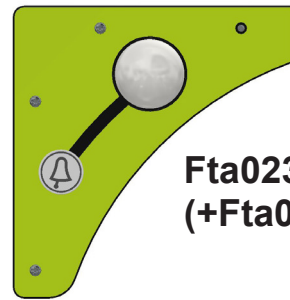

Fta023 x1
(+Fta024, Pzb678)

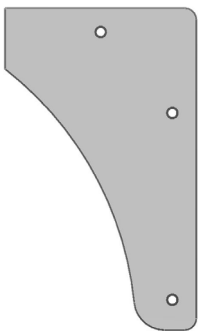

Fta025 x1



Fta026 x1

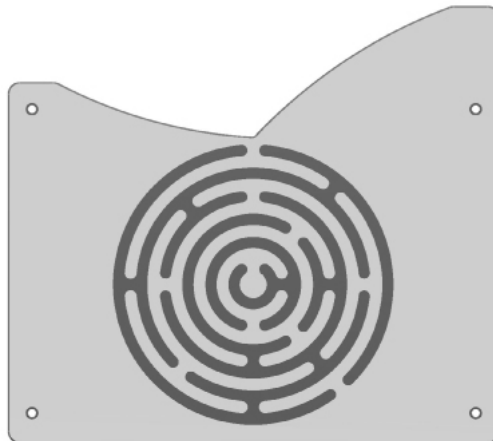

Fta027 x1

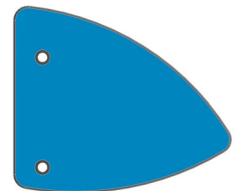

Fta028 x1

Ftw011

Unit
Parts List

design
make
play
SutcliffePlay



Fta029 x2

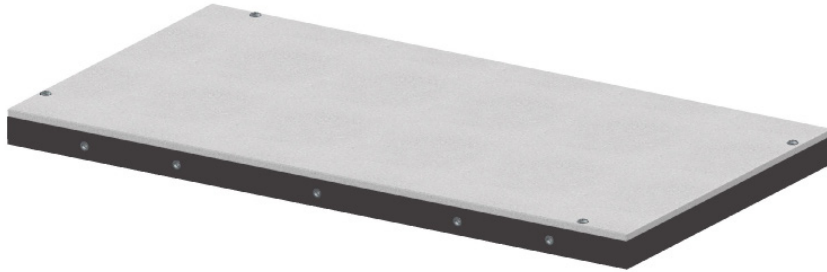

Fta032 x1

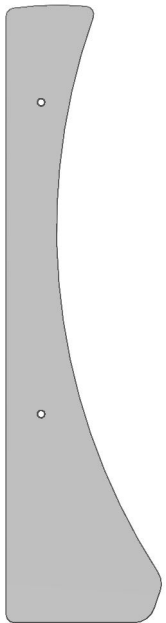

Fta035 x2

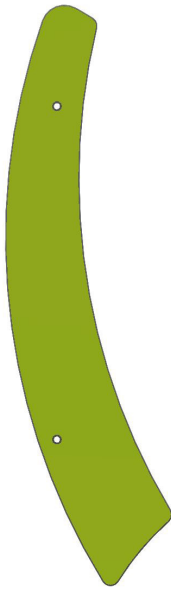

Fta036 x2

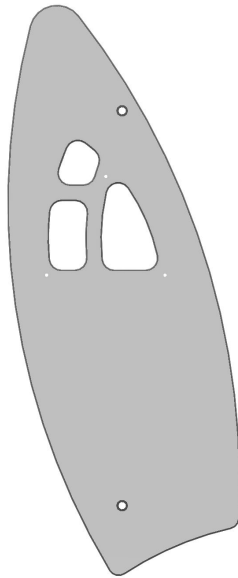

Fta037 x2



Fta038 x2



Fta039 x2



Fta034 x2



Fta040 x1



Fta041 x1

Ftw011

Unit
Parts List

design
make
play
SutcliffePlay



Fta043 x1

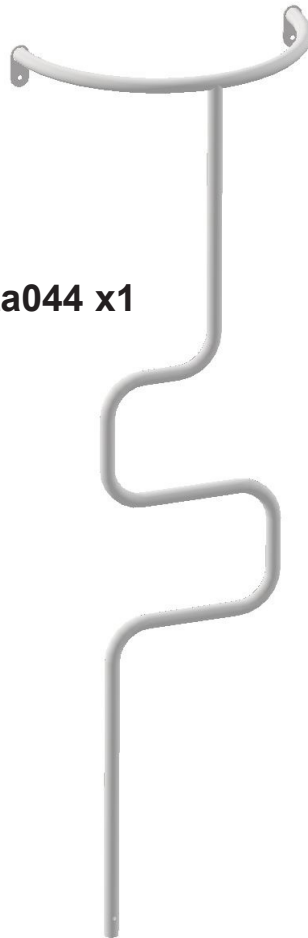

Fta044 x1



Fta045 x2
(0.65m Rail)

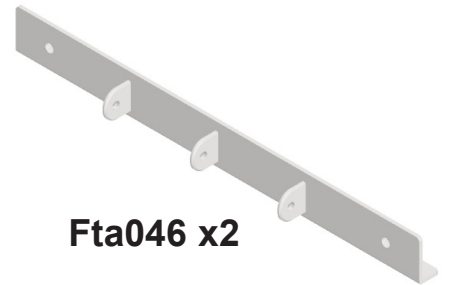

Fta046 x2

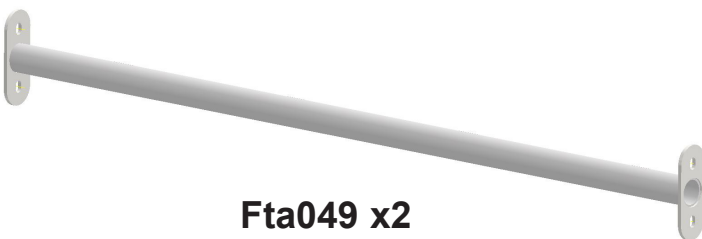

Fta049 x2



Fta051 x1



Fta052 x1
(+Pzb659,660,661)

Fta011

Unit
Parts List

design
make
play
SutcliffePlay

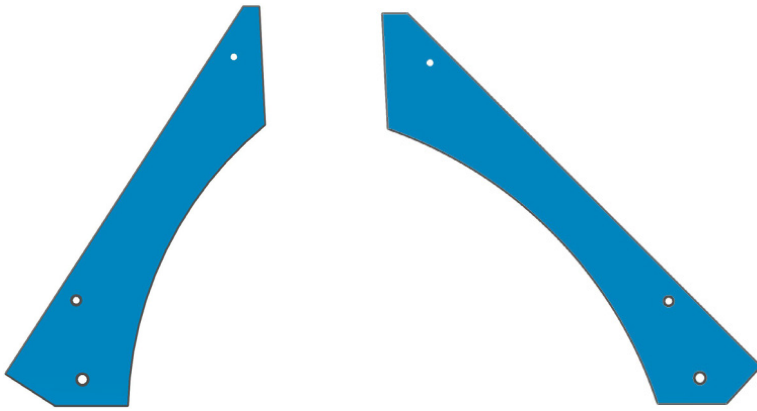

Fta004 x4

Fta005 x4

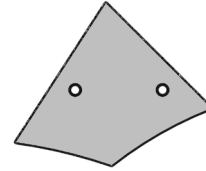

Fta006 x4

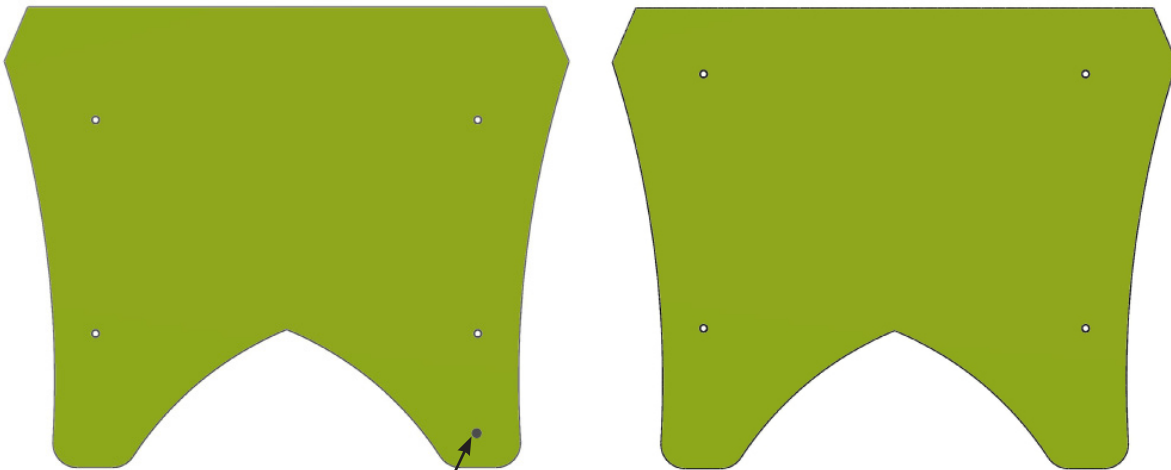

Fta007 x2
Identification Mark

Fta008 x2



Net032 x1



Ths050 x1

Ftw011

Standard Views

design
make
play
SutcliffePlay

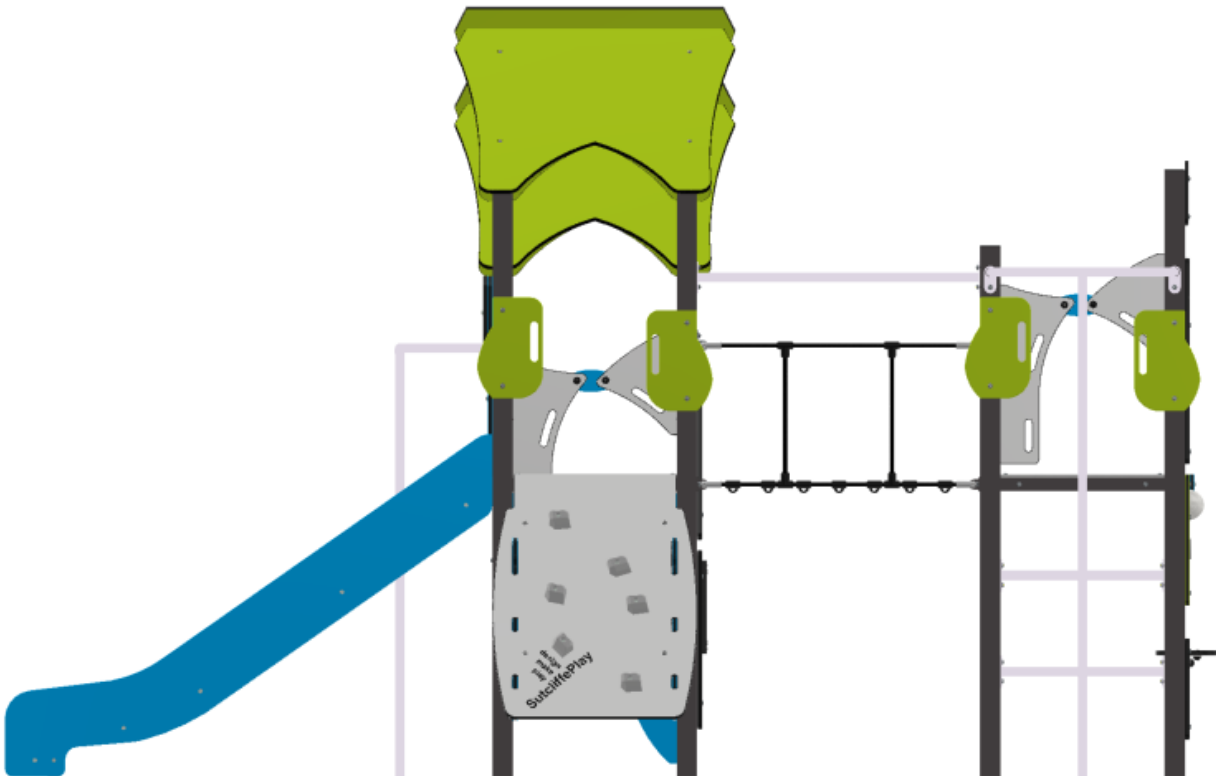
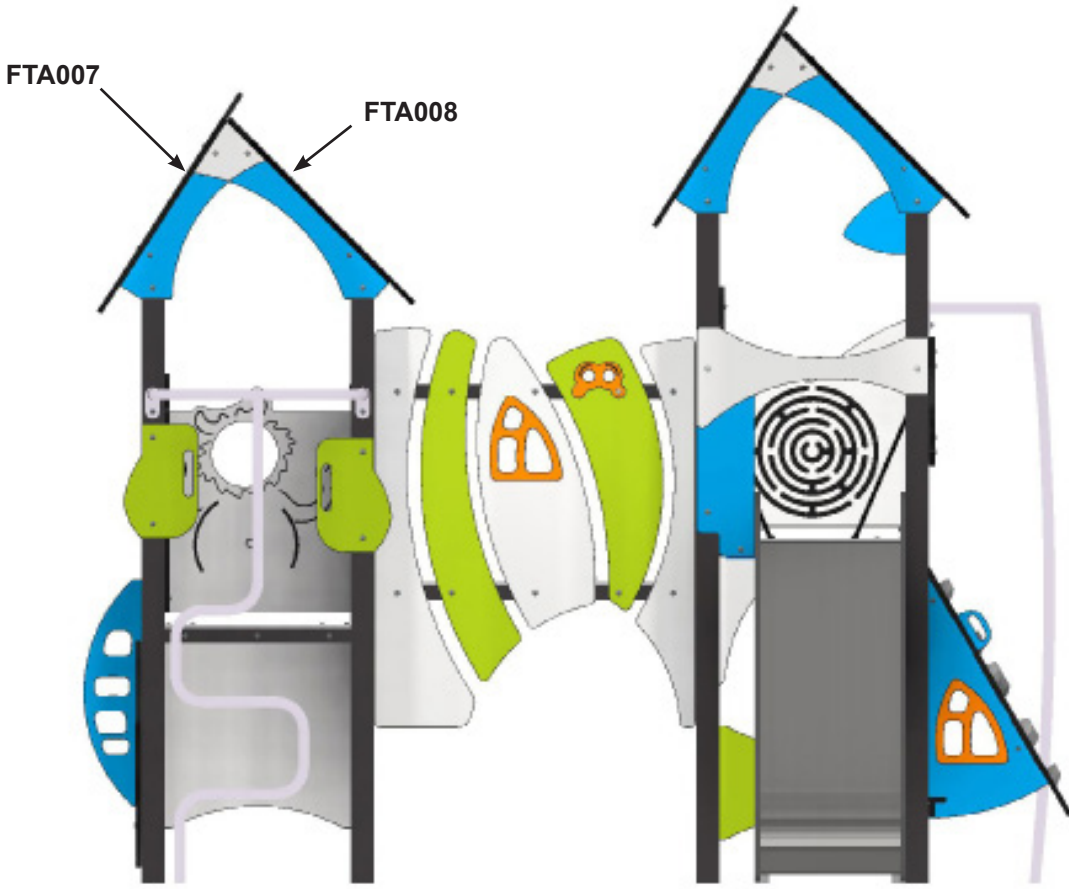

Ftw011

Standard Views

design
make
play
SutcliffePlay

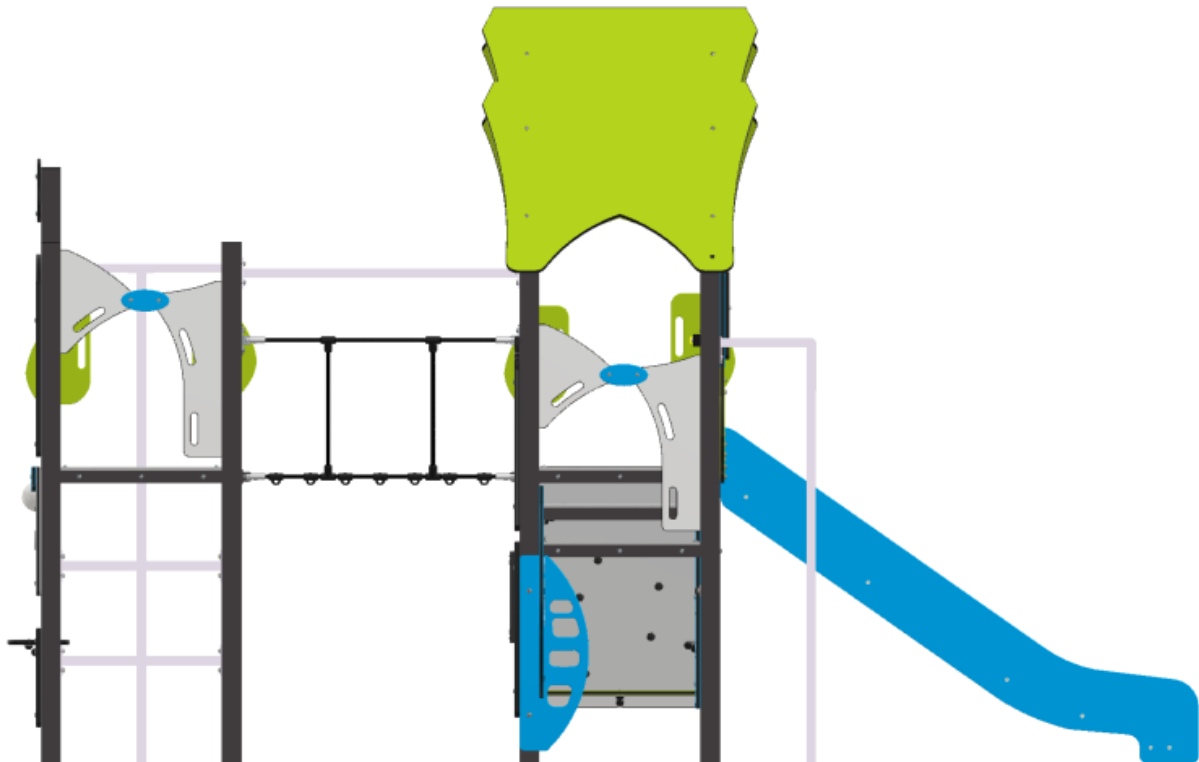
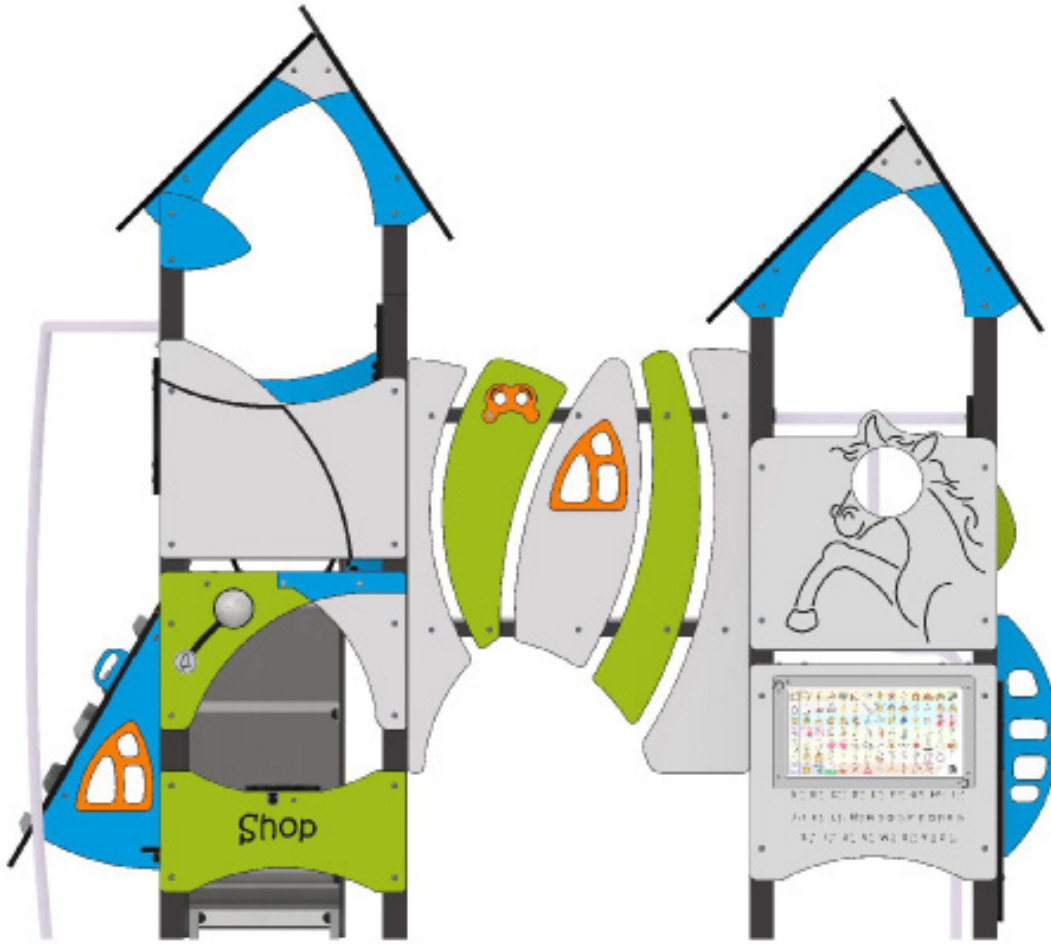

Ftw011

Deck Fixings

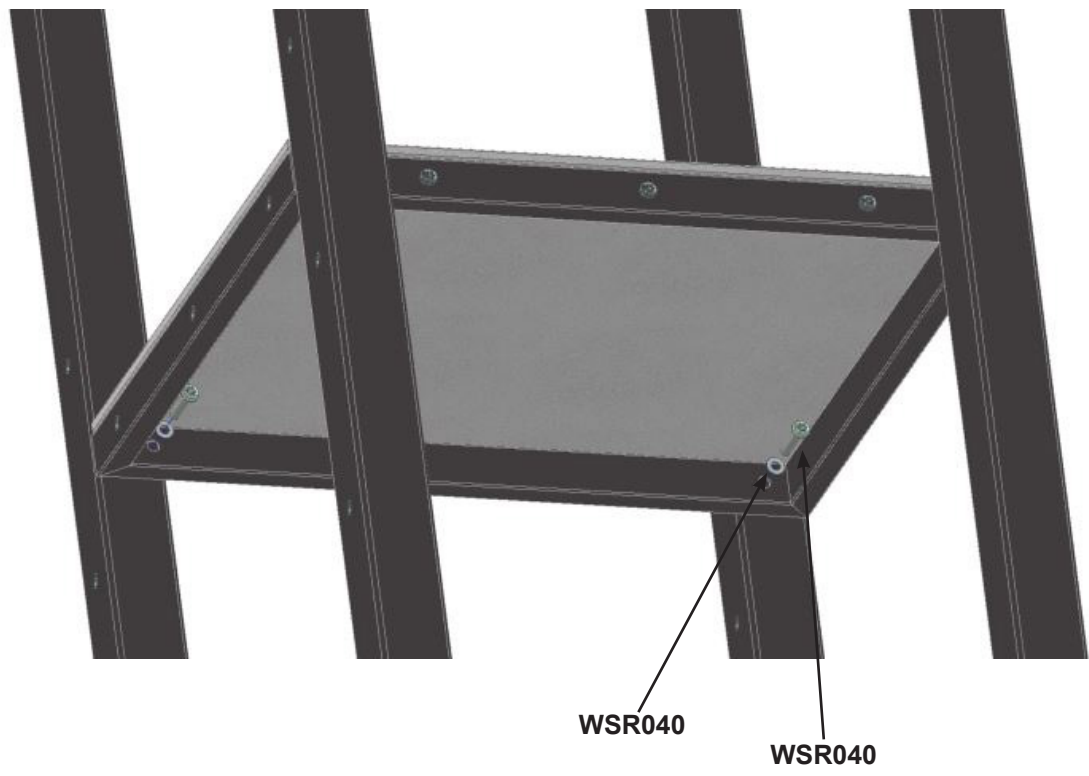

Ref	Description	Qty
WSR040	M10 Plain Washer	4
FIX160	M10 x 50 Security Bolt	4

Ftw011

Standard Fixings

19mm THK Panel to Framework.

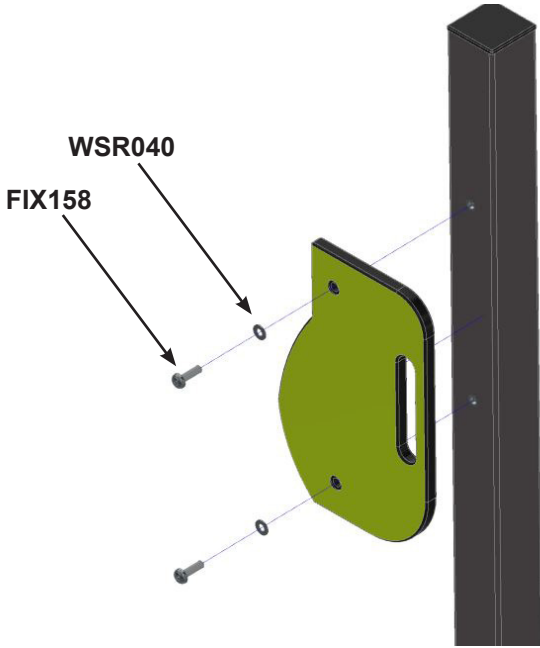

Ref	Description	Qty
WSR040	M10 Plain Washer	1
FIX158	M10 x 35 Security Bolt	1

5mm Plates to Framework.

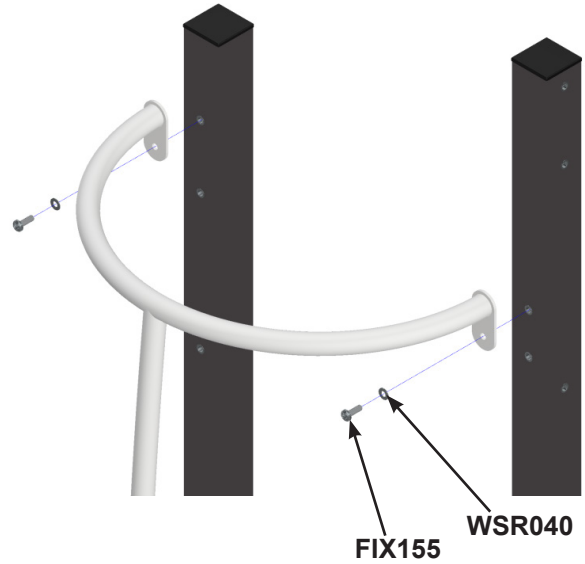

Ref	Description	Qty
WSR040	M10 Plain Washer	1
FIX155	M10 x 30 Security Bolt	1

19mm 2 Layers Panel to Framework.

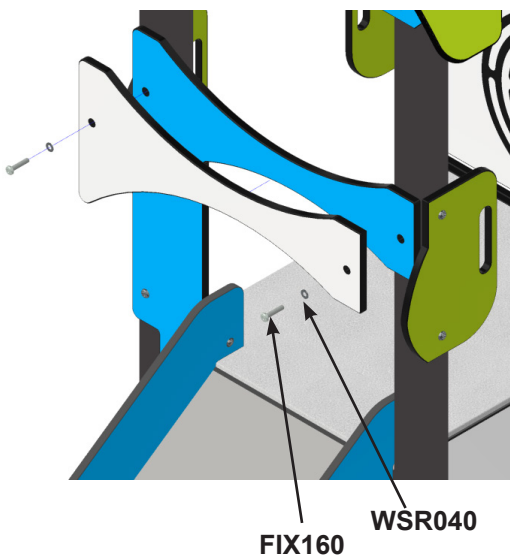

Ref	Description	Qty
WSR040	M10 Plain Washer	1
FIX160	M10 x 50 Security Bolt	1

Capping Holes.

FIX150
Cap all holes after unit is fully assembled.

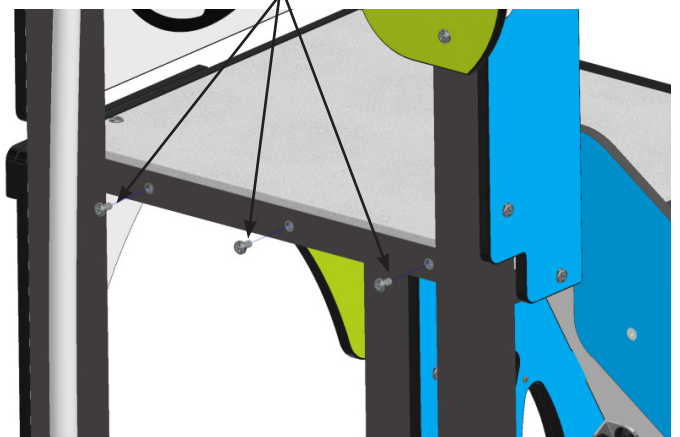

Ref	Description
FIX150	M10 x 20 Security Bolt

Ftw011

Assembly Fixings

Standard Entrance Fixings.

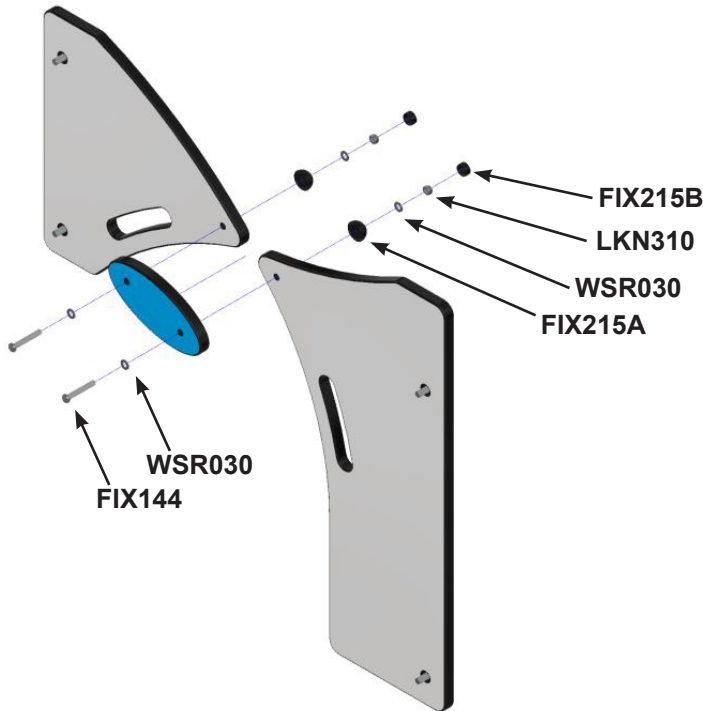

Ref	Description	Qty
WSR030	M8 Plain Washer	4
FIX144	M8 x 55 Security Bolt	2
FIX215A	M8 2 Part Cover - Base	2
LKN310	M8 Nyloc Nut	2
FIX215B	M8 2 Part Cover - Cap	2

Shop Assembly.

Ref	Description	Qty
FIX158	M10 x 35 Security Bolt	9
FIX160	M10 x 50 Security Bolt	2
WSR040	M10 Plain Washer	11
WSR030	M8 Plain Washer	8
FIX135	M8 x 35 Security Bolt	4
FIX215A	M8 2 Part Cover - Base	4
LKN310	M8 Nyloc Nut	4
FIX215B	M8 2 Part Cover - Cap	4
FTA050	L-Bracket 50 x 50 ST/ST	2

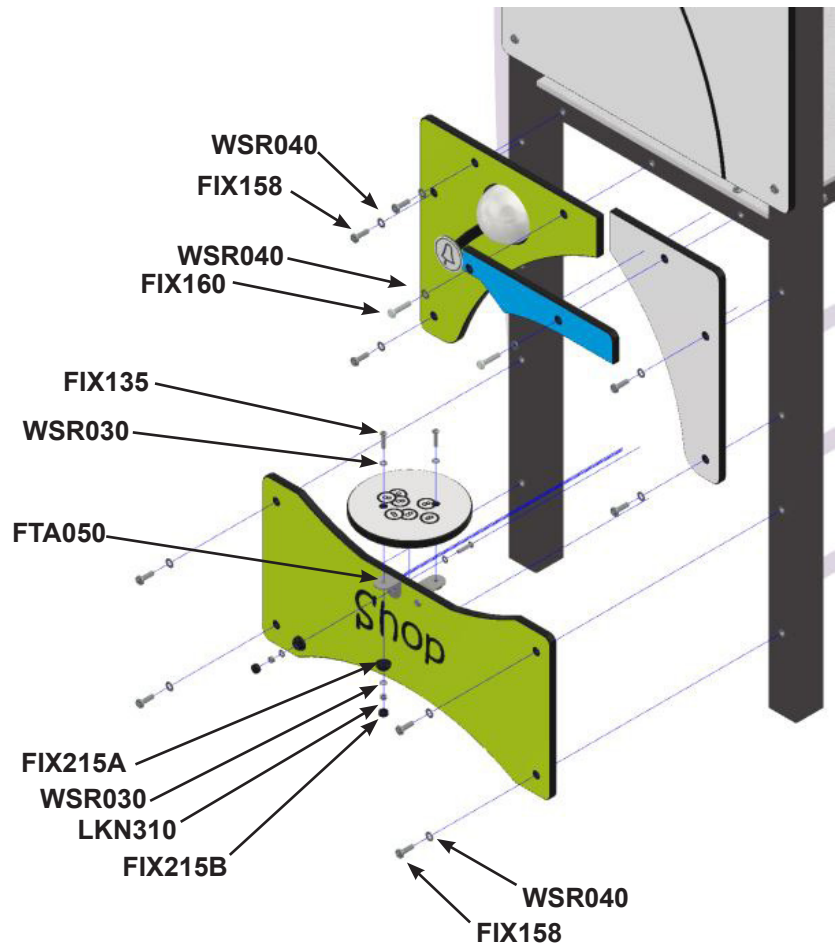

Ftw011

Assembly Fixings

Climbing Wall Assembly.

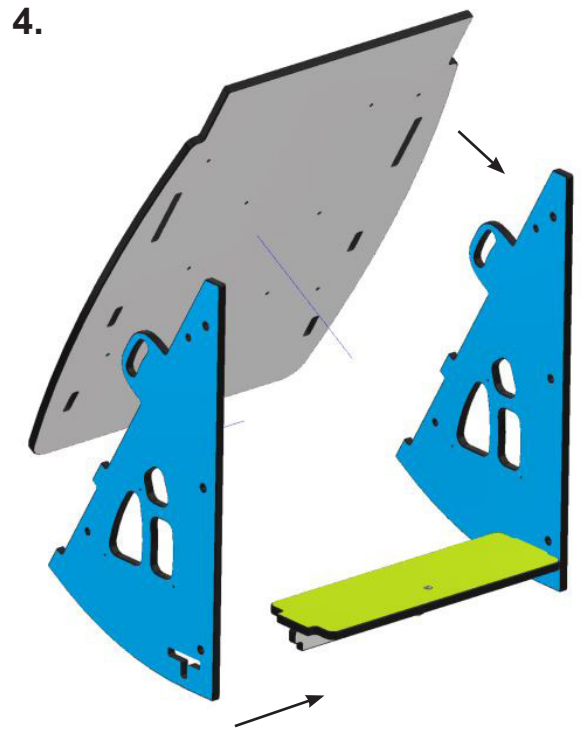
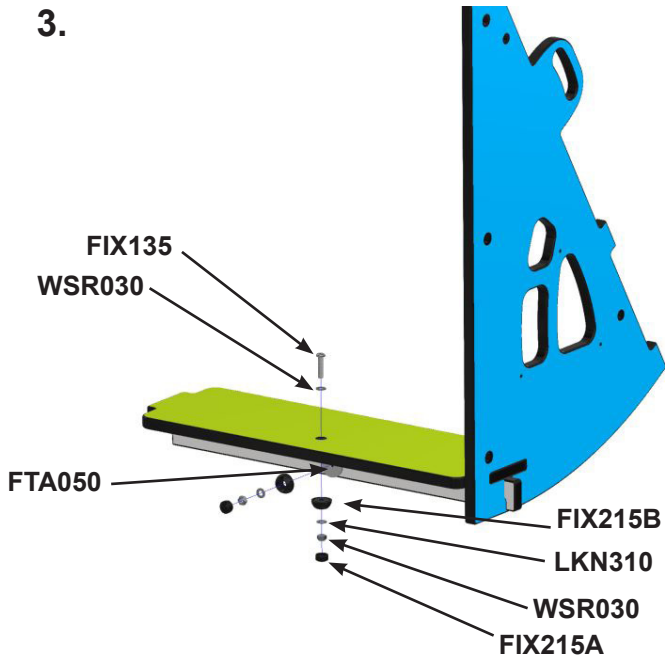
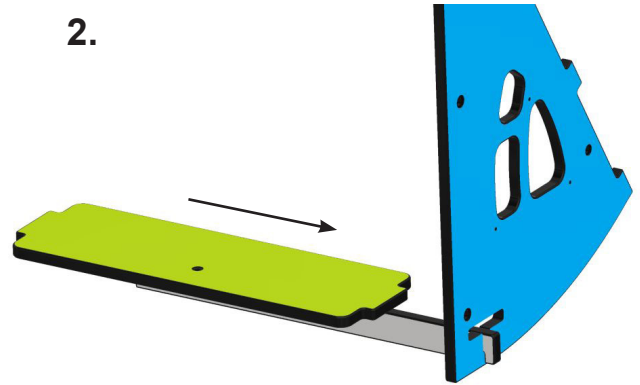
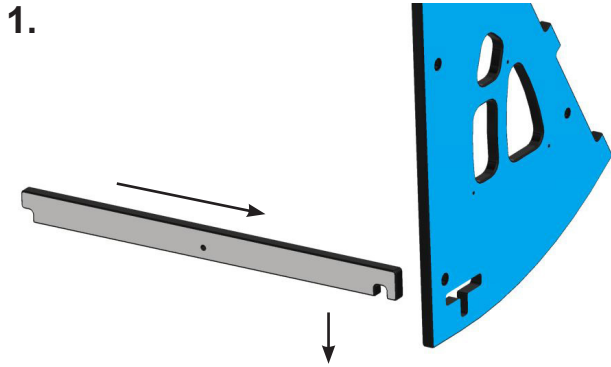

Ref	Description	Qty
WSR030	M8 Plain Washer	4
FIX135	M8 x 35 Security Bolt	2
FIX215A	M8 2 Part Cover - Base	2
LKN310	M8 Nyloc Nut	2
FIX215B	M8 2 Part Cover - Cap	2
FTA050	L-Bracket 50 x 50 St/St	1

Ftw011

Assembly Fixings

Climbing Wall Assembly.

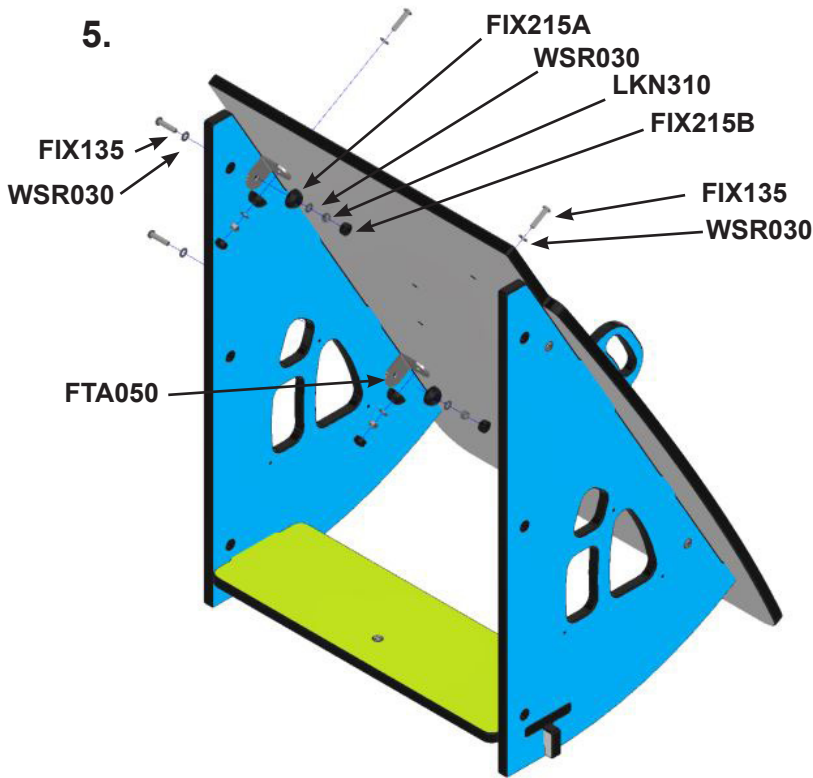

Ref	Description	Qty
WSR030	M8 Plain Washer	16
FIX135	M8 x 35 Security Bolt	8
FIX215A	M8 2 Part Cover - Base	8
LKN310	M8 Nyloc Nut	8
FIX215B	M8 2 Part Cover - Cap	8
FTA050	L-Bracket 50 x 50 St/St	4

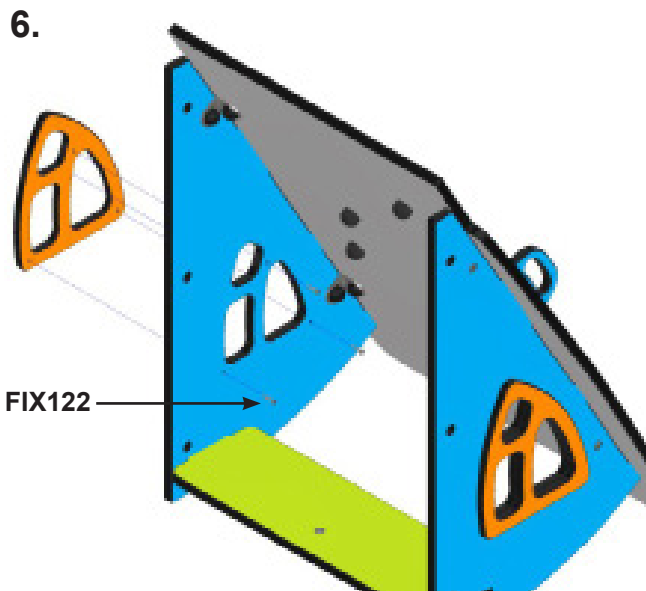

Ref	Description	Qty
FIX122	M5 x 25 Security Bolt	6

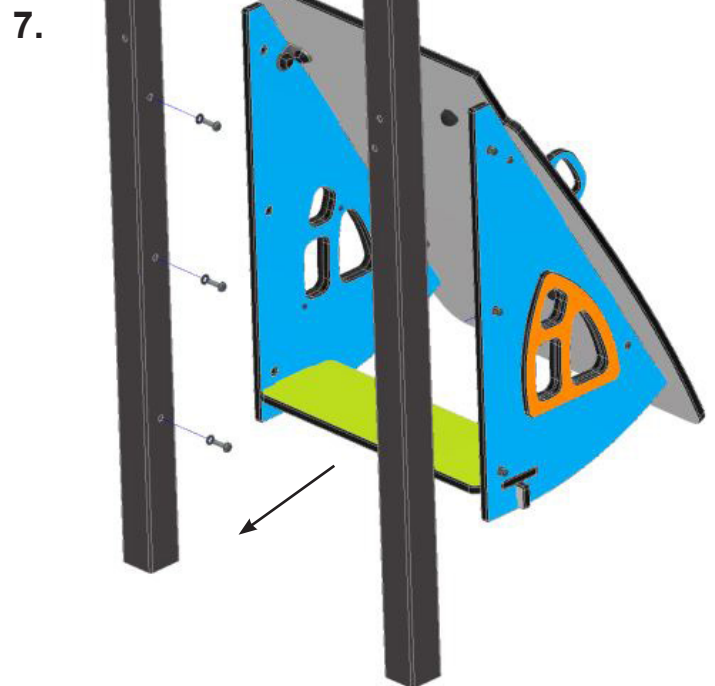

Ref	Description	Qty
WSR040	M10 Plain Washer	6
FIX158	M10 x 35 Security Bolt	6

Ftw011

Assembly Fixings

Roof Assembly.

1.

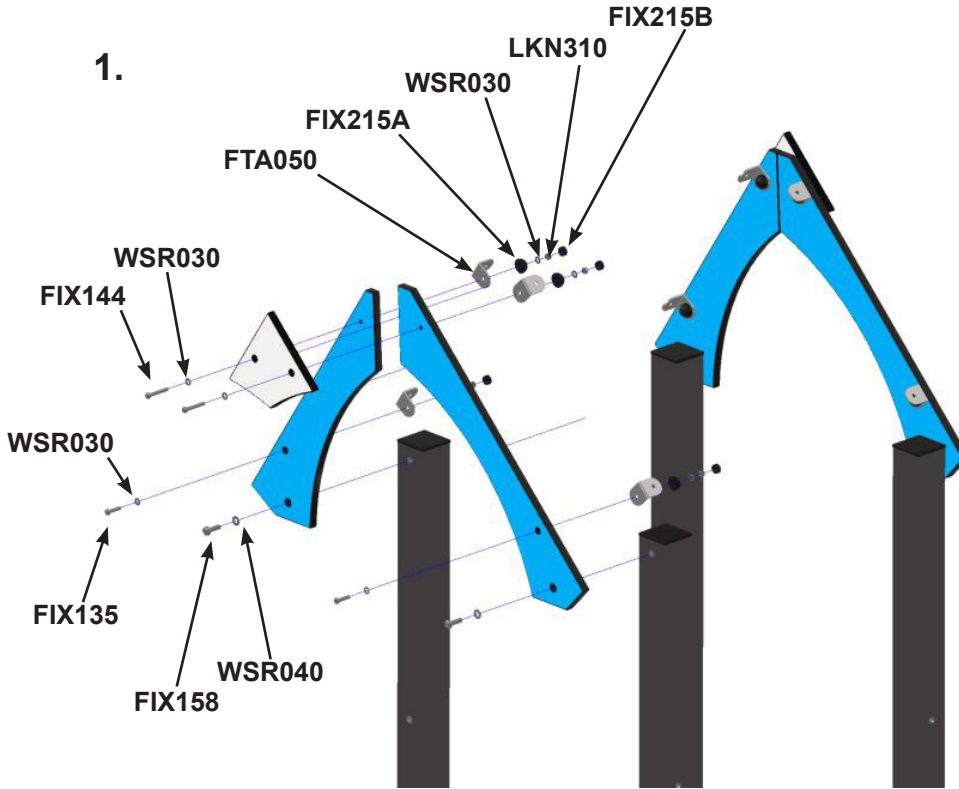

Ref	Description	Qty
WSR030	M8 Plain Washer	16
FIX135	M8 x 35 Security Bolt	8
FIX215A	M8 2 Part Cover - Base	8
LKN310	M8 Nyloc Nut	8
FIX215B	M8 2 Part Cover - Cap	8
FTA050	L-Bracket 50 x 50 St/St	8
FIX158	M10 x 35 Security Bolt	4
WSR040	M10 Plain Washer	4

2.

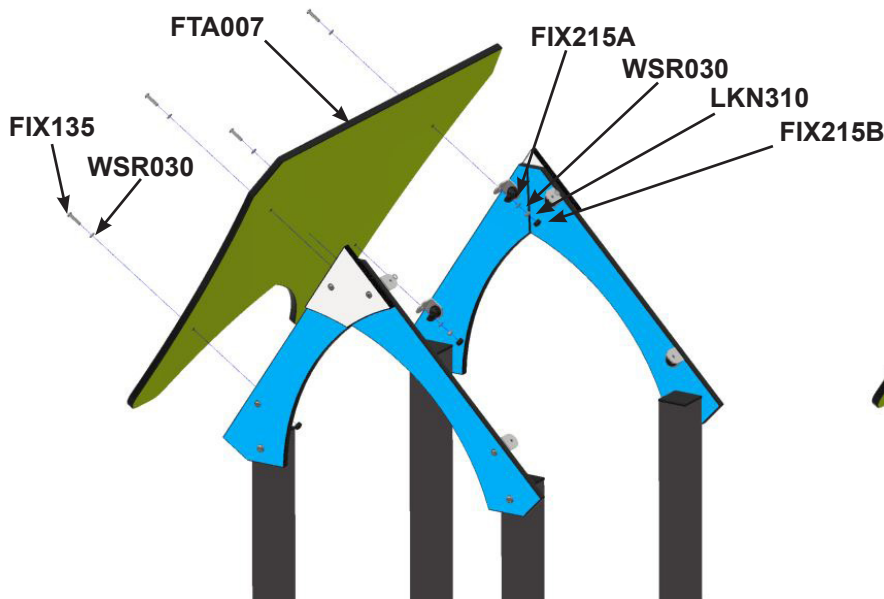

3. Repeat Step 2. with second roof panel.
Ensure gap at the top of Roof ridge
is less than 8mm

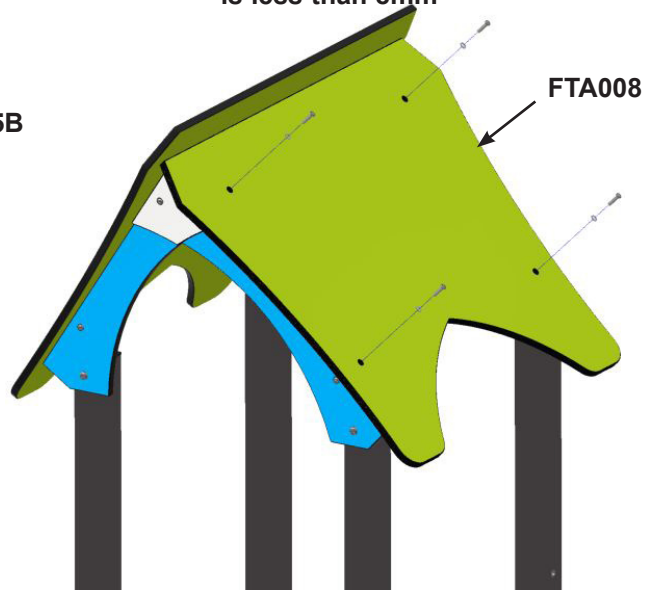

Ref	Description	Qty
WSR030	M8 Plain Washer	8
FIX135	M8 x 35 Security Bolt	4
FIX215A	M8 2 Part Cover - Base	4
LKN310	M8 Nyloc Nut	4
FIX215B	M8 2 Part Cover - Cap	4

Ref	Description	Qty
WSR030	M8 Plain Washer	8
FIX135	M8 x 35 Security Bolt	4
FIX215A	M8 2 Part Cover - Base	4
LKN310	M8 Nyloc Nut	4
FIX215B	M8 2 Part Cover - Cap	4

Ftw011

Assembly Fixings

Troll Bridge Assembly.

1.

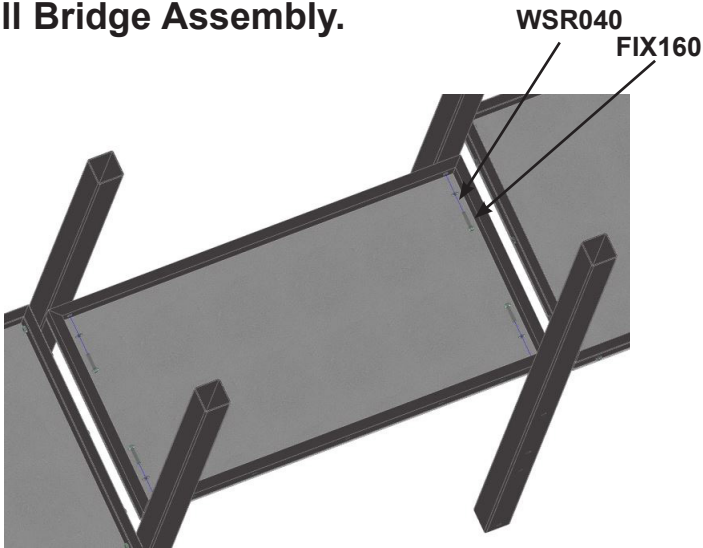

Ref	Description	Qty
WSR040	M10 Plain Washer	4
FIX160	M10 x 50 Security Bolt	4

2.

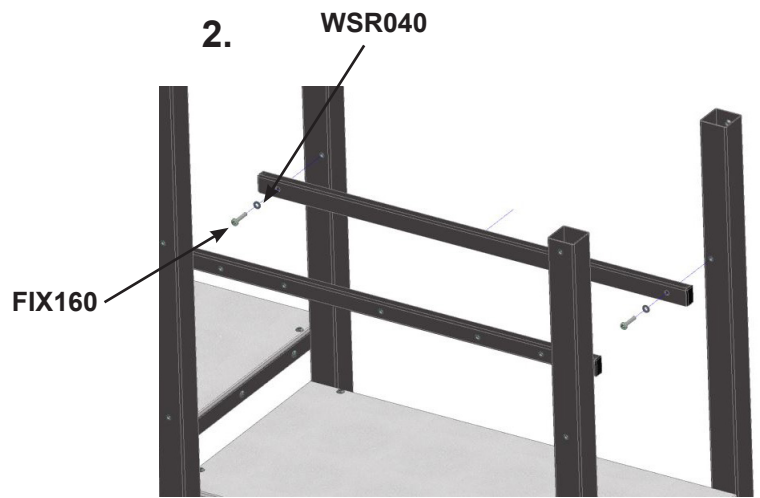

Ref	Description	Qty
WSR040	M10 Plain Washer	2
FIX160	M10 x 50 Security Bolt	2

Qys shown per side.

3. NOTE: Ensure gaps between panels are equally spaced at the top 40-45mm apart.

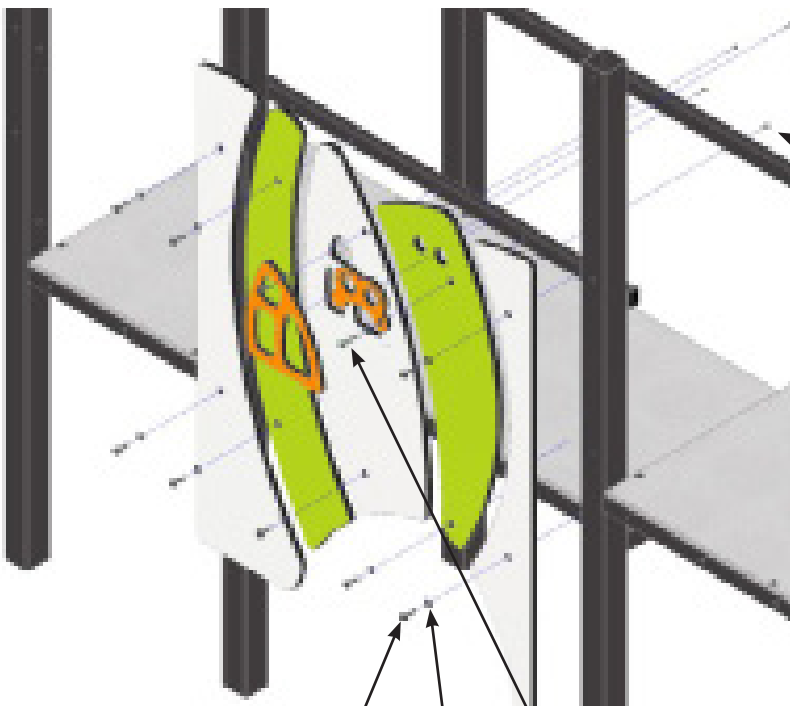

Ref	Description	Qty
WSR040	M10 Plain Washer	10
FIX160	M10 x 50 Security Bolt	1
FIX158	M10 x 35 Security Bolt	9
FIX122	M5 x 25 Security Bolt	4

Qtys shown per side.

Ftw011

Assembly Fixings

4. DZS002

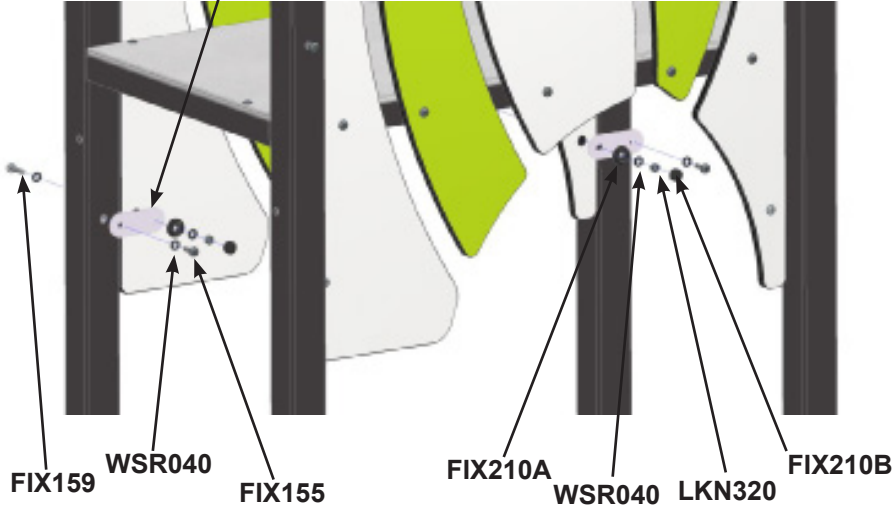

Ref	Description	Qty
DZS002	TOT Mounting Plate	2
WSR040	M10 Plain Washer	6
LKN320	M10 Nyloc Nut	2
FIX155	M10 x 30 Security Bolt	2
FIX159	M10 x 40 Security Bolt	2
FIX210A	M10 Nut Cover	2
FIX210B	M10 Nut Cap	2

Qty's shown per side.

V-Bridge Assembly.

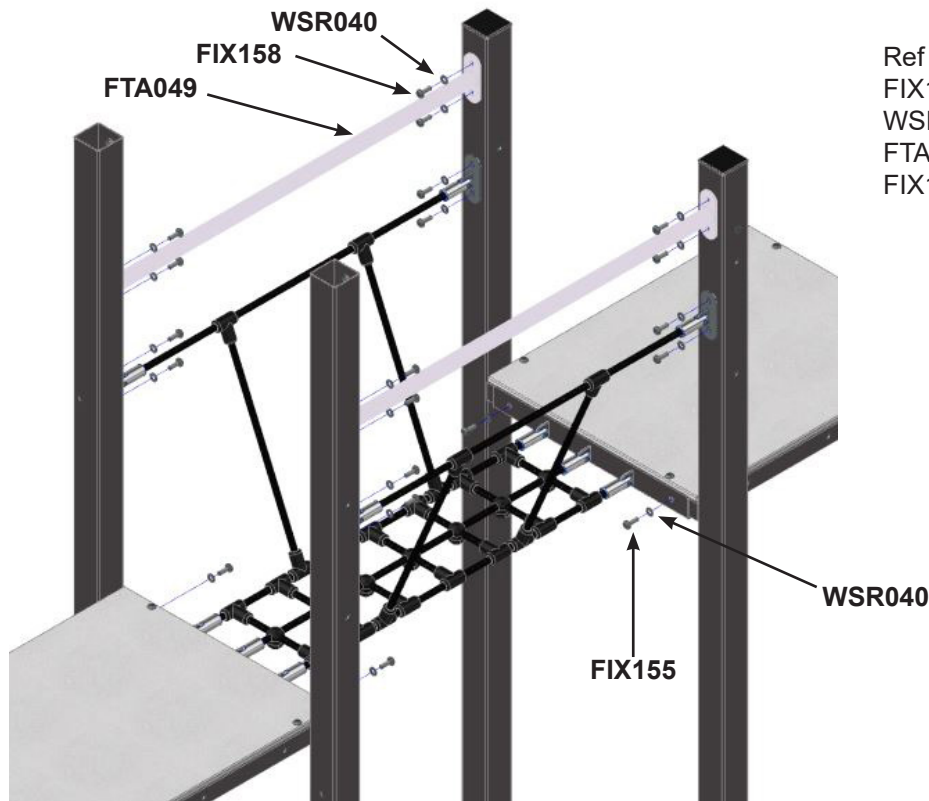

Ref	Description	Qty
FIX158	M10 x 35 Security Bolt	16
WSR040	M10 Plain Washer	20
FTA046	V-Bridge Deck Fixing Plate	2
FIX155	M10 x 30 Security Bolt	4

Ftw011

Slide Assembly

design
make
play
SutcliffePlay

1.

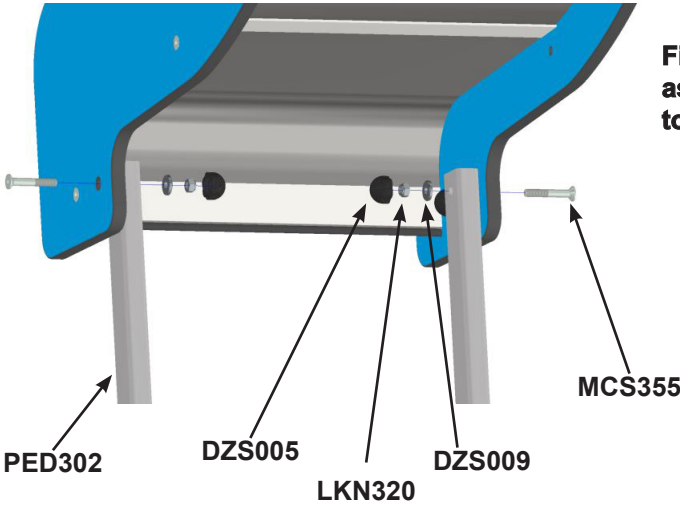

Fit PED302 to slide sides as shown, prior to fixing slide to the entrance panel / post.

Ref	Description	Qty
DZS005	M10 Nut Cover	2
LKN320	M10 Nyloc Nut	2
DZS009	M10 Step Washer	2
MCS355	M10 x 65 CSK Bolt	2
MSL002	200mm Spragging Iron	2

2.

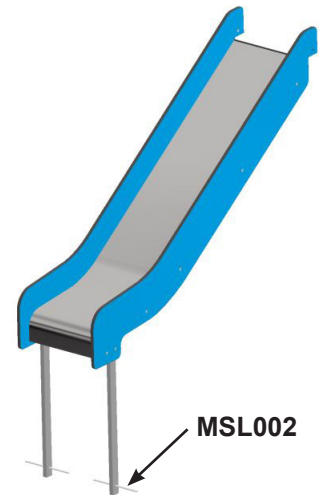
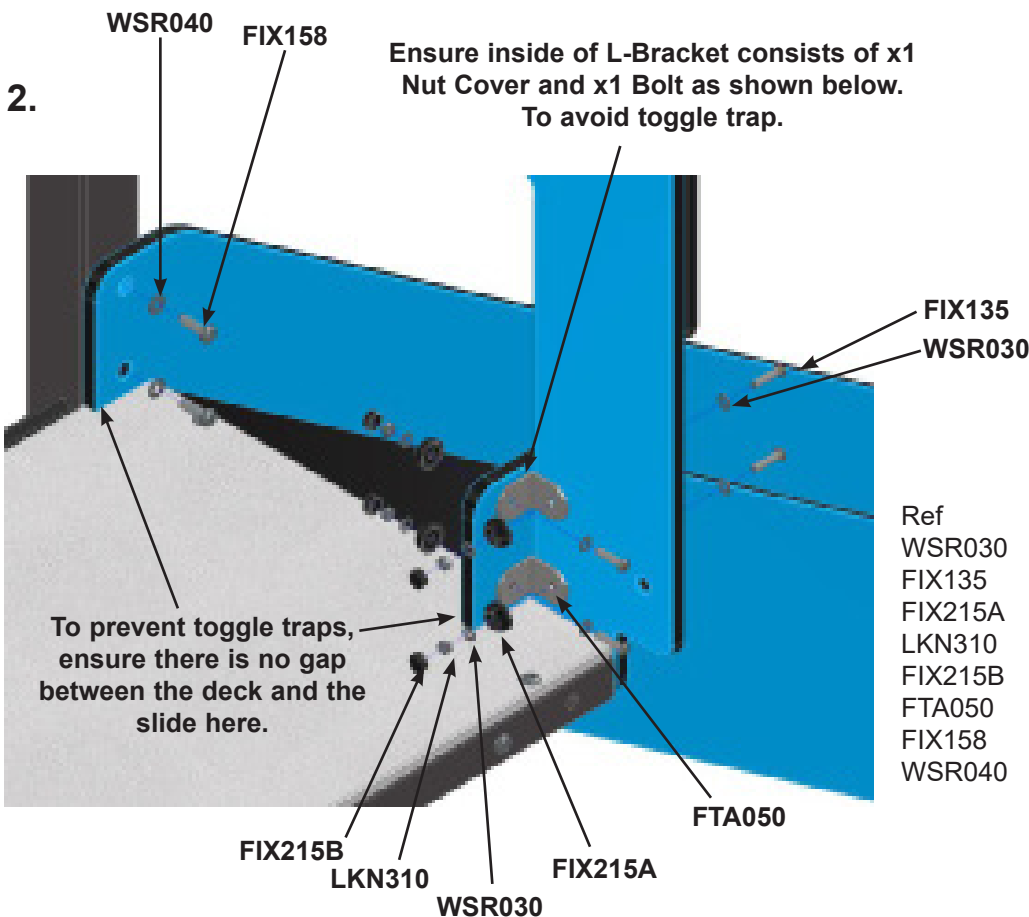

Ref	Description	Qty
WSR030	M8 Plain Washer	8
FIX135	M8 x 35 Security Bolt	4
FIX215A	M8 2 Part Cover - Base	4
LKN310	M8 Nyloc Nut	4
FIX215B	M8 2 Part Cover - Cap	4
FTA050	L-Bracket 50 x 50 St/St	2
FIX158	M10 x 35 Security Bolt	2
WSR040	M10 Plain Washer	2

Ftw011

Unit

Maintenance Instructions

NOTE

The warranty is invalidated if these instructions are not followed.
All wood needs annual inspection and retreatment where required.

Recommended Regular Inspection and Maintenance

	Interval Days				
	7	14	28	56	365
Check stability of structure, tighten connections if required.	<input type="checkbox"/>	<input type="checkbox"/>	<input type="checkbox"/>	<input checked="" type="checkbox"/>	<input type="checkbox"/>
Check all uprights at ground level for corrosion and/or rot. Replace any defective parts.	<input type="checkbox"/>	<input type="checkbox"/>	<input type="checkbox"/>	<input type="checkbox"/>	<input checked="" type="checkbox"/>
Check all painted elements for damage, rub down and repaint or replace as required.	<input type="checkbox"/>	<input type="checkbox"/>	<input type="checkbox"/>	<input checked="" type="checkbox"/>	<input type="checkbox"/>
Check chain/ropework assemblies for wear and damage, replace if required.	<input type="checkbox"/>	<input checked="" type="checkbox"/>	<input type="checkbox"/>	<input type="checkbox"/>	<input type="checkbox"/>
Check rotating and pivot points for wear and smooth running lubricate or replace if required.	<input type="checkbox"/>	<input type="checkbox"/>	<input checked="" type="checkbox"/>	<input type="checkbox"/>	<input type="checkbox"/>
Check rubber parts for wear and/or damage, replace if required.	<input type="checkbox"/>	<input type="checkbox"/>	<input checked="" type="checkbox"/>	<input type="checkbox"/>	<input type="checkbox"/>
Check tension cables, adjust if required.	<input type="checkbox"/>	<input type="checkbox"/>	<input checked="" type="checkbox"/>	<input type="checkbox"/>	<input type="checkbox"/>
Check wear of cables, replace if required.	<input type="checkbox"/>	<input type="checkbox"/>	<input checked="" type="checkbox"/>	<input type="checkbox"/>	<input type="checkbox"/>
Check slide chutes for smoothness and any foreign elements, remove any found.	<input type="checkbox"/>	<input type="checkbox"/>	<input checked="" type="checkbox"/>	<input type="checkbox"/>	<input type="checkbox"/>
Check rubber safety surfaces for damage and poor performance, repair or replace if required.	<input type="checkbox"/>	<input type="checkbox"/>	<input type="checkbox"/>	<input checked="" type="checkbox"/>	<input type="checkbox"/>
Check loose fill safety surfaces, remove any foreign elements, rake level and top up if required.	<input type="checkbox"/>	<input type="checkbox"/>	<input checked="" type="checkbox"/>	<input type="checkbox"/>	<input type="checkbox"/>

Disposal Instructions

All components should be broken down into categories of:-

- 1 **Mild Steel** - all activities and frames
- 2 **Stainless Steel** - all Slides, Mirror Panels.
- 3 **Aluminium** - all Playzone and Toddlerzone Posts.
- 4 **Galvanised Steel** - all Chains and Teenzone Posts.
- 5 **Moulded Rubber Products without steel inserts** - all Toddlerzone Caps and edge details.
- 6 **Timber** - all natural timber, plywood, and MDF panels.

Wherever possible these materials should be taken to specialist recycling organisations and recycled.

In some cases where composite materials are used, then disposal at land fill sites is the only alternative such as:

- 7 **Moulded Rubber Products encasing steel inserts** - all Swing Seats, Deck Tops, Duo/Dizzy Disc Tops.
- 8 **High Pressure Laminate** - all Toddlerzone, Playzone and Teenzone Panels.
- 9 **Steel Core Polypropylene Rope** - all Scramble Nets, Space Nets, Playzone/Toddlerzone Ropes.
- 10 **High Density Polyethylene** - Fantasy Range Panels.