

Spring rocker Ugo



Age indication



Balance

Scope of delivery

1x spring rocker body: robinia
1x spring: spring steel

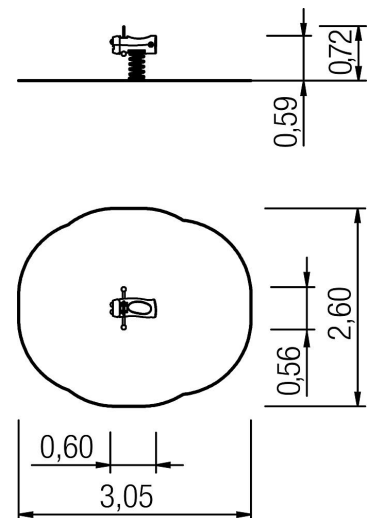



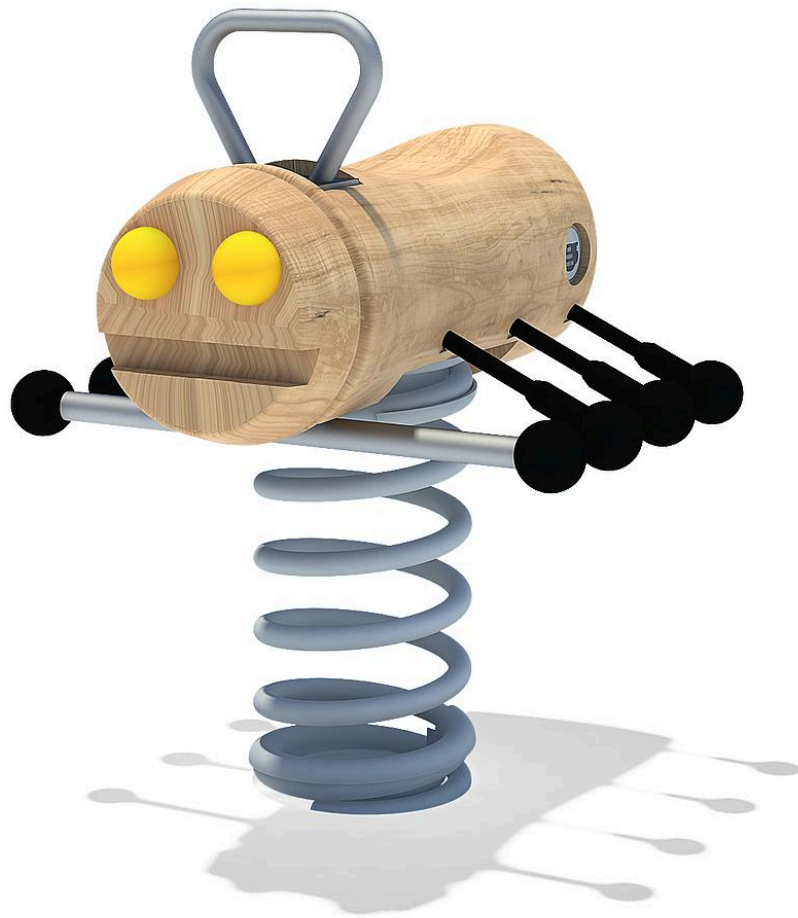







Spring rocker Ugo



Technical data

	Material	Robinia natural
	Minimum space	3,05x2,60x2,39 m
	Impact protection net	6,5 m ²
	Free falling height	59 cm
	Ground constitution GE/NL/B	at least lawn
	Ground constitution all except GE/NL/B	at least lawn
	Size	SH 59 cm
	Largest section	60x56x39 cm
	mx. number of users	1
	Certificate	Z2_010651_0535_Rev00
	Tested according to standard	EN 1176 - 1/7

Installation information

	Foundations	1x 5632280 + 1x CF or 1x 5632290 + 1x CF
	Fundamentlevel	ET 0
	Assembly	2 persons/1 h
	PF Accessories	-
	PF drainage	-
	PF concrete	-
	PF excavation	-
	CF Accessories	-
	CF drainage	0,04 m ³
	CF concrete	0,06 m ³
	CF excavation	0,20 m ³



5 45 401 060 00

Spring rocker Ugo



CO₂ emissions of the product

89,8 kg

Material share of renewable raw materials

19%

Recyclate content

75%

Circularity score



Weighted emission factor of the product*



Disclaimer:

This dashboard for the circularity index of the 'Circular Product' certification was generated automatically and is based on the corresponding certification of eibe Produktion + Vertrieb GmbH & Co KG, Industriestraße 1, 97285 Röttingen, which was issued on 16 May 2024 by the Gesellschaft für Klimaschutz München GmbH (GKM GmbH) on the basis of the example product Albion play unit from the eibe unique® product line. eibe Produktion + Vertrieb GmbH & Co KG is liable for the accuracy of the contents. The award criteria of the private-law certification 'Circular Product' of GKM GmbH can be viewed at gesellschaft-klimaschutz.de/zertifizierung/zirkularitaet/.

* The CO₂e emissions of the materials used in the product are taken into account. The emissions that arise during the production process are allocated to the product on a pro-rata basis.

created on: 14 August 2024