

# water play unit Farlon



Age indication



Social skills



Experiencing the



Senses



Something new to

## Scope of delivery



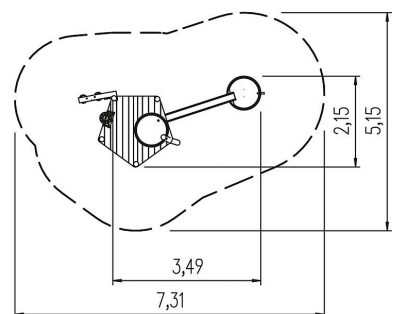
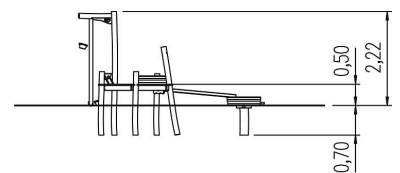



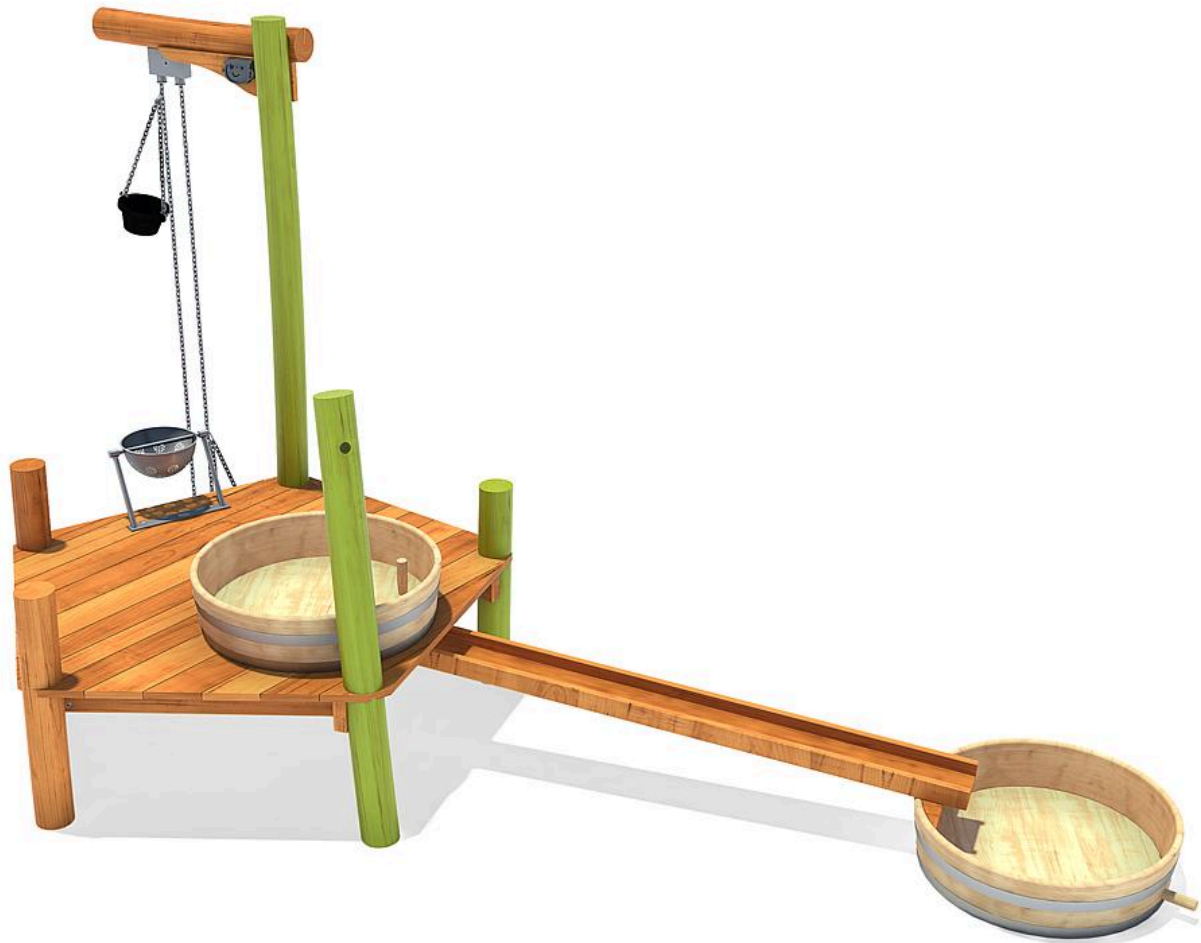

- 1x post with hose holder: robinia
- 1x platform surface PH 45 cm: robinia
- 1x sand crane: stainless steel, rubber
- 2x tub: robinia
- 1x water trough: robinia
- 1x sand sieve: stainless steel









# water play unit Farlon



## Technical data

	Material	Robinia oiled
	Minimum space	7,31x5,15x2,30 m
	Impact protection net	-
	Free falling height	50 cm
	Ground constitution GE/NL/B	at least stone
	Ground constitution all except GE/NL/B	at least stone
	Certificate	Z2_010651_0525_Rev00
	Tested according to standard	EN 1176 - 1/7

## Installation information

	Foundations	6x CF
	Fundamentlevel	ET 700
	PF Accessories	-
	PF drainage	-
	PF concrete	-
	PF excavation	-



5 45 144 053 06

# water play unit Farlon



**CO<sub>2</sub> emissions of the product**

**159 kg**

**Material share of renewable raw materials**

**91%**

**Recyclate content**

**8%**

Circularity score



Weighted emission factor of the product\*



**Disclaimer:**

This dashboard for the circularity index of the 'Circular Product' certification was generated automatically and is based on the corresponding certification of eibe Produktion + Vertrieb GmbH & Co KG, Industriestraße 1, 97285 Röttingen, which was issued on 16 May 2024 by the Gesellschaft für Klimaschutz München GmbH (GKM GmbH) on the basis of the example product Albion play unit from the eibe unique® product line. eibe Produktion + Vertrieb GmbH & Co KG is liable for the accuracy of the contents. The award criteria of the private-law certification 'Circular Product' of GKM GmbH can be viewed at [gesellschaft-klimaschutz.de/zertifizierung/zirkularitaet/](https://gesellschaft-klimaschutz.de/zertifizierung/zirkularitaet/).

\* The CO<sub>2</sub>e emissions of the materials used in the product are taken into account. The emissions that arise during the production process are allocated to the product on a pro-rata basis.

created on: 14 August 2024