

play unit Winni, solo



Age indication



Speed



Fitness



Something new to



Knowledge



Living together



Social skills



Inclusion

Scope of delivery

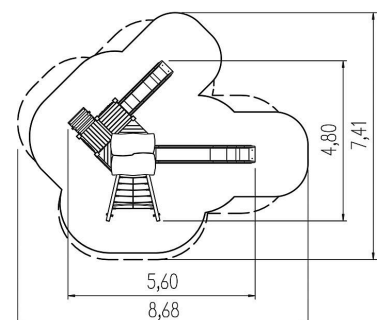
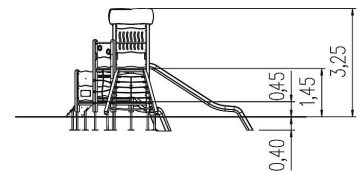

9x post construction: SW
 9x post shoe: steel galvanised
 5x platform construction: SW
 2x adapter: SW
 4x wall panel: HPL
 2x walk-through protection leaf: stainless steel
 3x set of grips: aluminium, plastic coated
 1x house roof: HPL
 2x cord protection: HPL
 1x net ascent oblique: polyester-coated steel cable, stainless steel
 1x net ascent vertical: polyester-coated steel cable
 1x ramp: HPL, SW
 2x slide entry plate: HPL
 1x play panel click wheel: HPL, stainless steel, plastic
 1x play panel hole: HPL, perspex
 1x play panel wavy grooves: HPL
 1x play panel dice disc: HPL, steel galvanised
 1x play panel gear wheel: HPL
 1x play panel counting rings: HPL, ROB
 fittings: stainless steel













play unit Winni, solo



Technical data

	Material	SW pi
	Minimum space	7,62x7,24x3,25 m
	Impact protection net	33,0 m ²
	Free falling height	145 cm
	Ground constitution GE/NL/B	at least turf
	Ground constitution all except GE/NL/B	at least sand
	mx. number of users	18
	Certificate	Z2_010651_0526_Rev00
	Tested according to standard	EN 1176 - 1/3/7

Installation information

	Foundations	12x CF or 12x PFs
	Fundamentlevel	ET 400
	Assembly	2 persons/7 h
	PF Accessories	12x 5632540
	PF drainage	-
	PF concrete	-
	PF excavation	2,75 m ³
	CF drainage	-
	CF concrete	0,62 m ³
	CF excavation	1,46 m ³

Accessories

-  Slides for platform heights: 1x 60 cm, 1x 145 cm
- Installation accessories e.g. PF
- Please order accessories separately to complete the appliance.



5 11 011 011 10 play unit Winni, solo

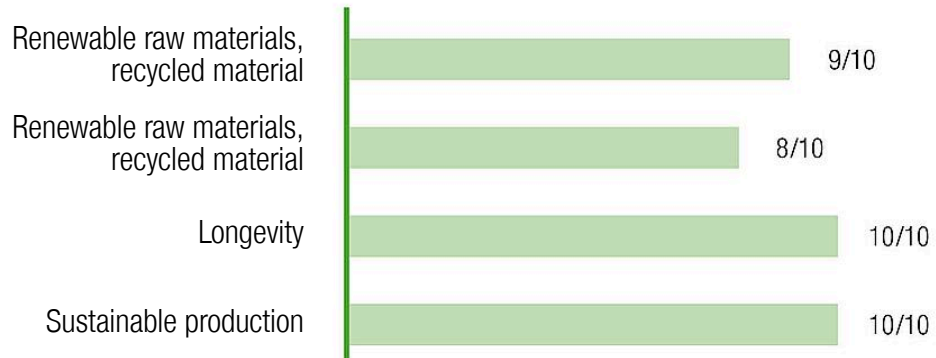

CO₂ emissions of the product

905,8 kg

Material share of renewable raw materials

56%

Recyclate content

11%

Circularity score

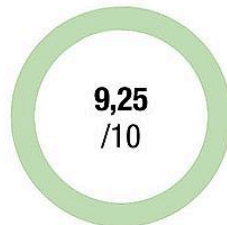

Weighted emission factor of the product*



Disclaimer:

This dashboard for the circularity index of the 'Circular Product' certification was generated automatically and is based on the corresponding certification of eibe Produktion + Vertrieb GmbH & Co KG, Industriestraße 1, 97285 Röttingen, which was issued on 16 May 2024 by the Gesellschaft für Klimaschutz München GmbH (GKM GmbH) on the basis of the example product Albion play unit from the eibe unique® product line. eibe Produktion + Vertrieb GmbH & Co KG is liable for the accuracy of the contents. The award criteria of the private-law certification 'Circular Product' of GKM GmbH can be viewed at gesellschaft-klimaschutz.de/zertifizierung/zirkularitaet/.

* The CO₂e emissions of the materials used in the product are taken into account. The emissions that arise during the production process are allocated to the product on a pro-rata basis.

created on: 14 August 2024