

Play house Lago



Age indication



Fitness



Recreation



Imagination



Living together



Inclusion

Scope of delivery

- 1x platform surface: robinia
- 1x saddle roof: robinia
- 1x play counter: robinia
- 1x seat board: robinia
- 1x rung ladder: robinia
- 1x rood window: robinia
- 1x climbing rope: plastic-coated steel cable

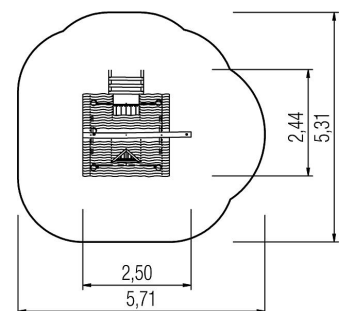
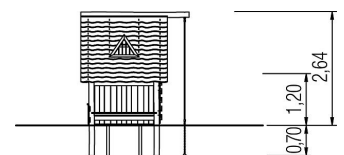











Play house Lago



Technical data

	Material	Robinia natural
	Minimum space	5,71x5,31x2,64 m
	Impact protection net	25,5 m ²
	Free falling height	149 cm
	Ground constitution GE/NL/B	at least turf
	Ground constitution all except GE/NL/B	at least sand
	Size	260x260x290 cm
	Largest section	250x192x334 cm
	Heaviest section	600 kg
	Certificate	Z2_010651_0535_Rev00
	Tested according to standard	EN 1176 - 1/7

Installation information

	Foundations	8x CF
	Fundamentlevel	ET 700
	Lifting devices	Wheel loader
	PF Accessories	-
	PF drainage	-
	PF concrete	-
	PF excavation	-
	CF Accessories	-
	CF drainage	0,19 m ³
	CF concrete	0,58 m ³
	CF excavation	1,54 m ³



5 45 081 063 00

Play house Lago



CO₂ emissions of the product

138,9 kg

Material share of renewable raw materials

98%

Recyclate content

1%

Circularity score



Weighted emission factor of the product*

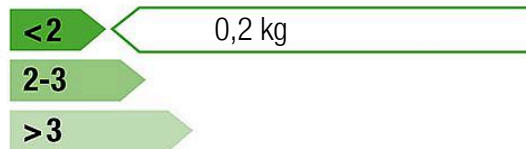

Disclaimer:

This dashboard for the circularity index of the 'Circular Product' certification was generated automatically and is based on the corresponding certification of eibe Produktion + Vertrieb GmbH & Co KG, Industriestraße 1, 97285 Röttingen, which was issued on 16 May 2024 by the Gesellschaft für Klimaschutz München GmbH (GKM GmbH) on the basis of the example product Albion play unit from the eibe unique® product line. eibe Produktion + Vertrieb GmbH & Co KG is liable for the accuracy of the contents. The award criteria of the private-law certification 'Circular Product' of GKM GmbH can be viewed at gesellschaft-klimaschutz.de/zertifizierung/zirkularitaet/.

* The CO₂e emissions of the materials used in the product are taken into account. The emissions that arise during the production process are allocated to the product on a pro-rata basis.

created on: 14 August 2024