

5 55 330 5

# Climbing bridge Rock'n'Roll



Age indication



Fitness



Social skills



Senses

## Scope of delivery

- 2x post: softwood
- 1x cross beam: softwood
- 8x handle: plastic coated steel cable
- 4x cover: high pressure laminate (HPL)
- 2x post shoe: galvanised steel

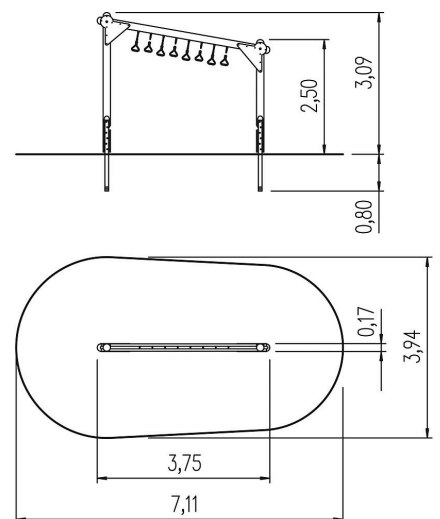











5 55 330 5











# Climbing bridge Rock'n'Roll



## Technical data

	Material	SW pi
	Minimum space	7,11x3,94x3,09 m
	Impact protection net	24,0 m <sup>2</sup>
	Free falling height	220 cm
	Ground constitution GE/NL/B	at least sand
	Ground constitution all except GE/NL/B	at least sand
	Largest section	381xØ 16 cm
	Heaviest section	58 kg
	Certificate	-
	Tested according to standard	-

## Installation information

	Foundations	2x CF
	Fundamentlevel	ET 400
	Assembly	2 persons/2 h
	PF Accessories	-
	PF drainage	-
	PF concrete	-
	PF excavation	-
	CF Accessories	-
	CF drainage	0,17 m <sup>3</sup>
	CF concrete	0,98 m <sup>3</sup>
	CF excavation	1,46 m <sup>3</sup>

Legend: PF=prefabricated foundation, CF=concrete foundation, ET=burial depth, GFRP=glass-fibre reinforced plastic, VA=stainless steel, PH=platform height



5 55 330 5

# Climbing bridge Rock'n'Roll



**CO<sub>2</sub> emissions of the product**

**380,2 kg**

**Material share of renewable raw materials**

**67%**

**Recyclate content**

**22%**

Circularity score



Weighted emission factor of the product\*

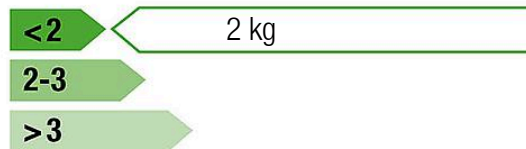

**Disclaimer:**

This dashboard for the circularity index of the 'Circular Product' certification was generated automatically and is based on the corresponding certification of eibe Produktion + Vertrieb GmbH & Co KG, Industriestraße 1, 97285 Röttingen, which was issued on 16 May 2024 by the Gesellschaft für Klimaschutz München GmbH (GKM GmbH) on the basis of the example product Albion play unit from the eibe unique® product line. eibe Produktion + Vertrieb GmbH & Co KG is liable for the accuracy of the contents. The award criteria of the private-law certification 'Circular Product' of GKM GmbH can be viewed at [gesellschaft-klimaschutz.de/zertifizierung/zirkularitaet/](https://gesellschaft-klimaschutz.de/zertifizierung/zirkularitaet/).

\* The CO<sub>2</sub>e emissions of the materials used in the product are taken into account. The emissions that arise during the production process are allocated to the product on a pro-rata basis.

created on: 14 August 2024