

5 55 327 5

balance Paso Doble professional

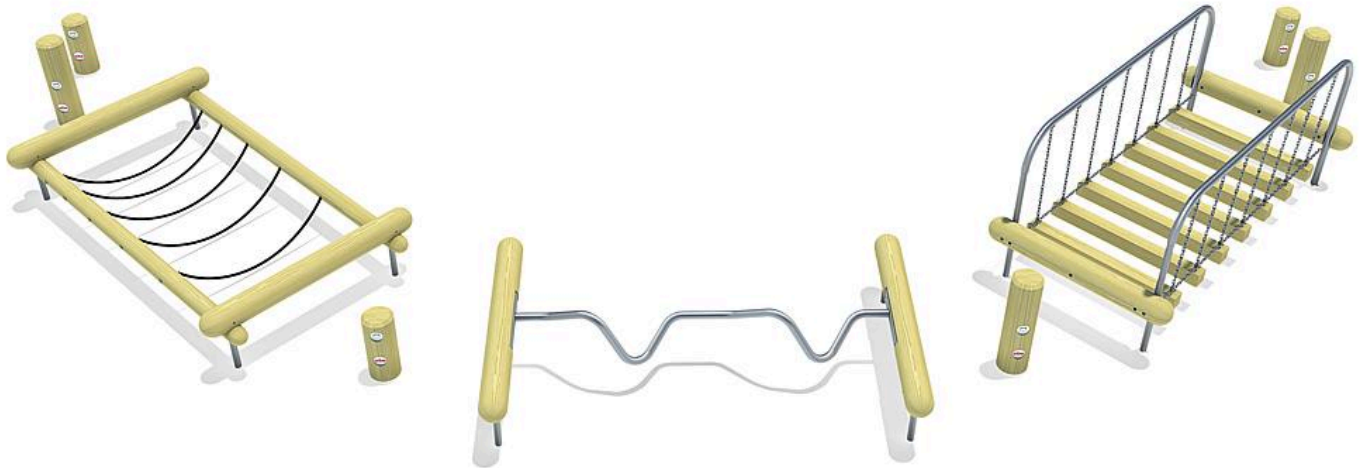

Age indication



Fitness



Balance



Social skills



Senses

Scope of delivery

balance Paso doble profi combination consisting of:

1x tube course Boogy Woogy: softwood

1x wobbly bridge Cha Cha Cha: softwood

1x net bridge Samba: softwood, plastic coated steel cable

3x Step 40: softwood





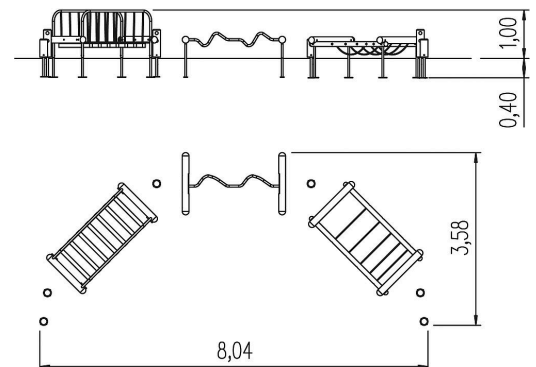

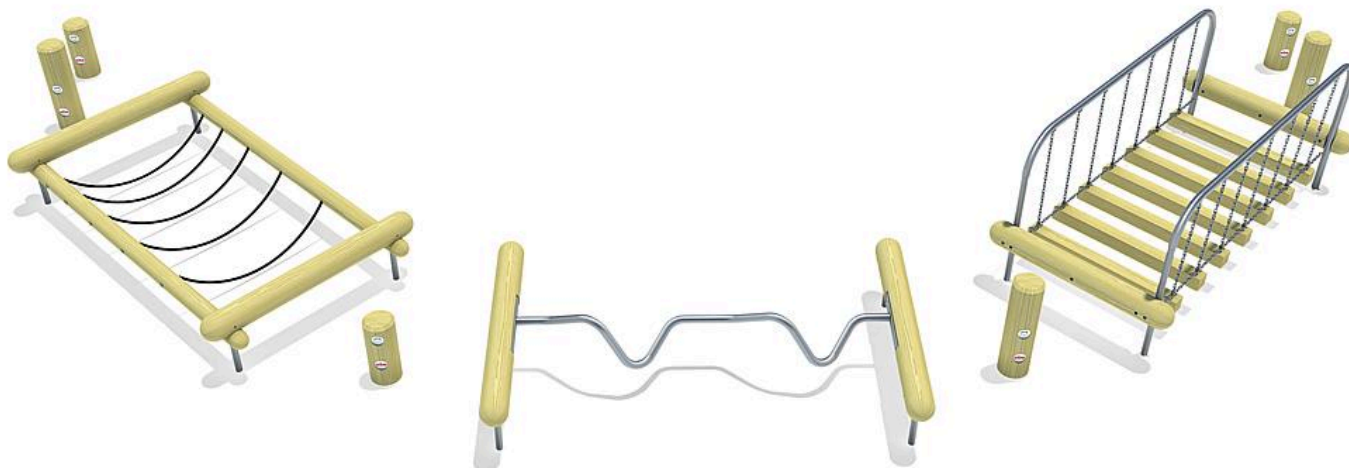



3x Step 60: softwood

18x post shoe: galvanised steel















Technical data

	Material	SW pi
	Minimum space	8,06x3,59x2,39 m
	Impact protection net	-
	Free falling height	54 cm
	Ground constitution GE/NL/B	at least stone
	Ground constitution all except GE/NL/B	at least stone
	Largest section	242x116xØ 42 cm
	Heaviest section	60 kg
	Certificate	-
	Tested according to standard	-

Installation information

	Foundations	18x CF or 12x PFs + 6x CF
	Fundamentlevel	ET 400
	Assembly	2 persons/6 h
	PF Accessories	12x 5632540
	PF drainage	0,06 m ³
	PF concrete	0,14 m ³
	PF excavation	3,08 m ³
	CF Accessories	12 x 5631120
	CF drainage	0,06 m ³
	CF concrete	0,71 m ³
	CF excavation	1,67 m ³



5 55 327 5

balance Paso Doble professional



CO₂ emissions of the product

659,6 kg

Material share of renewable raw materials

60%

Recyclate content

36%

Circularity score



Weighted emission factor of the product*



Disclaimer:

This dashboard for the circularity index of the 'Circular Product' certification was generated automatically and is based on the corresponding certification of eibe Produktion + Vertrieb GmbH & Co KG, Industriestraße 1, 97285 Röttingen, which was issued on 16 May 2024 by the Gesellschaft für Klimaschutz München GmbH (GKM GmbH) on the basis of the example product Albion play unit from the eibe unique® product line. eibe Produktion + Vertrieb GmbH & Co KG is liable for the accuracy of the contents. The award criteria of the private-law certification 'Circular Product' of GKM GmbH can be viewed at gesellschaft-klimaschutz.de/zertifizierung/zirkularitaet/.

* The CO₂e emissions of the materials used in the product are taken into account. The emissions that arise during the production process are allocated to the product on a pro-rata basis.

created on: 14 August 2024