

play unit Lisa



Age indication



Knowledge



Fitness



Creativity



Inclusion





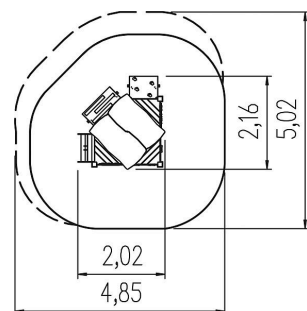
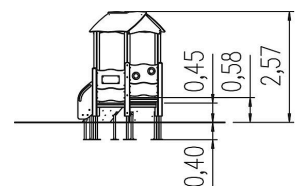



Scope of delivery

- 7x post construction: SW
- 7x post shoe: steel galvanised
- 4x adapter: SW
- 4x platform construction: SW
- 4x wall panel: HPL
- 2x set of grips: aluminium, plastic coated
- 1x house roof: HPL
- 1x ramp: HPL, climbing grips
- 1x ramp: HPL, SW
- 1x play panel click wheel: HPL, stainless steel, plastic
- 1x play panel hole: HPL, perspex
- 1x play panel gear wheel: HPL
- 1x play panel counting rings: HPL, ROB
- 1x staircase: SW, HPL
- fittings: stainless steel















Technical data

	Material	SW pi
	Minimum space	5,03x4,91x2,57 m
	Impact protection net	-
	Free falling height	58 cm
	Ground constitution GE/NL/B	at least stone
	Ground constitution all except GE/NL/B	at least stone
	mx. number of users	22
	Certificate	Z2_010651_0526_Rev04
	Tested according to standard	EN 1176 - 1/7

Installation information

	Foundations	11x CF or 8x PFs + 3x FFr
	Fundamentlevel	ET 400
	Assembly	2 persons/5 h
	PF Accessories	8x 5632540 + 3x 5632550
	PF drainage	-
	PF concrete	-
	PF excavation	0,89 m³
	CF drainage	-
	CF concrete	0,60 m³
	CF excavation	1,40 m³



5 11 001 011 10 play unit Lisa

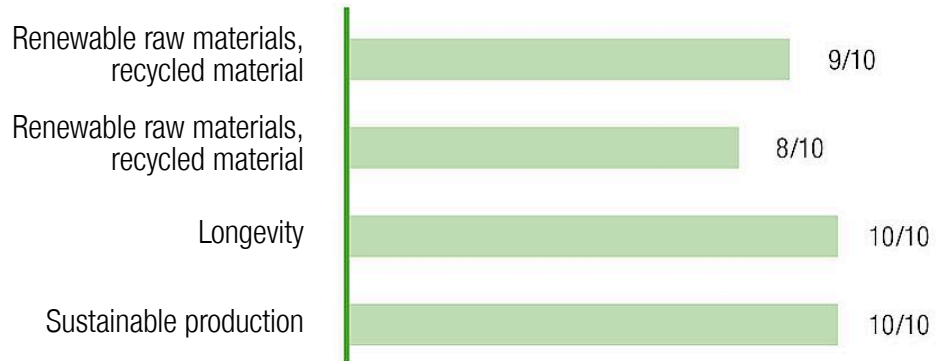

CO₂ emissions of the product

679,5 kg

Material share of renewable raw materials

53%

Recyclate content

12%

Circularity score

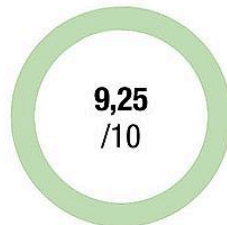

Weighted emission factor of the product*



Disclaimer:

This dashboard for the circularity index of the 'Circular Product' certification was generated automatically and is based on the corresponding certification of eibe Produktion + Vertrieb GmbH & Co KG, Industriestraße 1, 97285 Röttingen, which was issued on 16 May 2024 by the Gesellschaft für Klimaschutz München GmbH (GKM GmbH) on the basis of the example product Albion play unit from the eibe unique® product line. eibe Produktion + Vertrieb GmbH & Co KG is liable for the accuracy of the contents. The award criteria of the private-law certification 'Circular Product' of GKM GmbH can be viewed at gesellschaft-klimaschutz.de/zertifizierung/zirkularitaet/.

* The CO₂e emissions of the materials used in the product are taken into account. The emissions that arise during the production process are allocated to the product on a pro-rata basis.

created on: 14 August 2024