

play unit Apple Tree

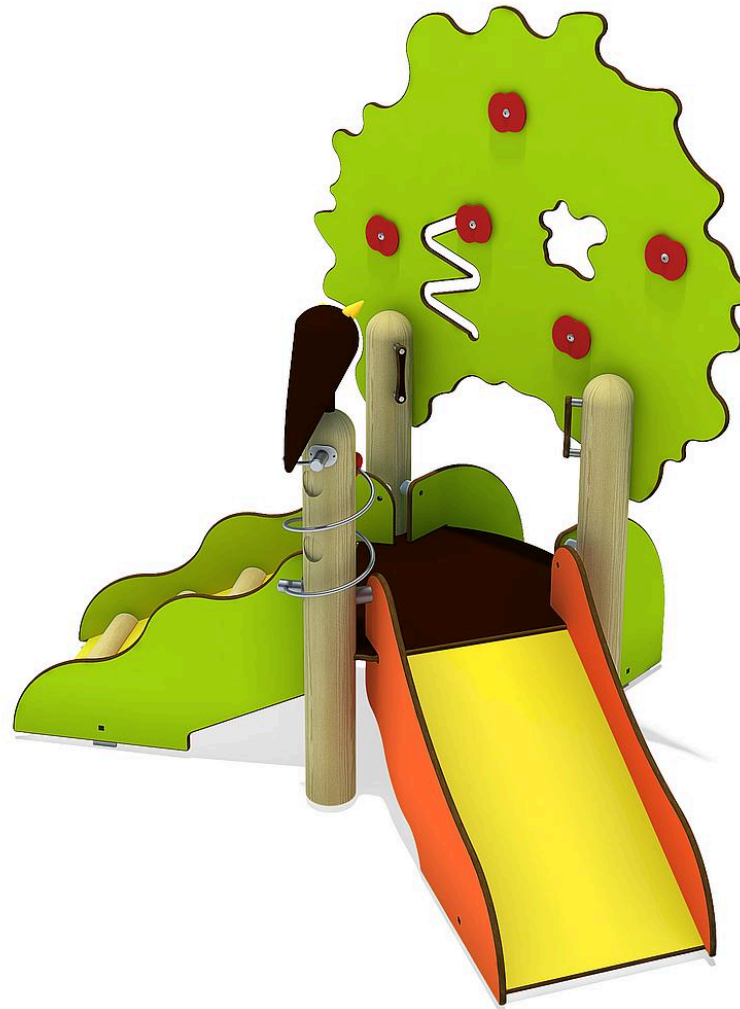

Age indication



Fitness



Imagination



Fine motor skills

Scope of delivery



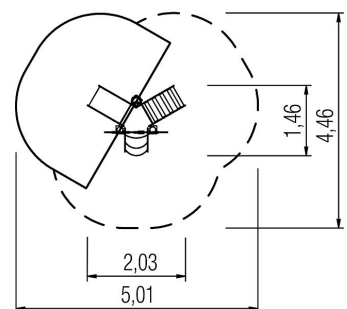
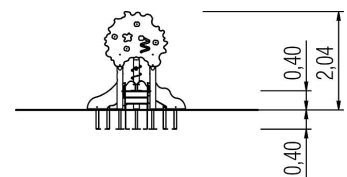



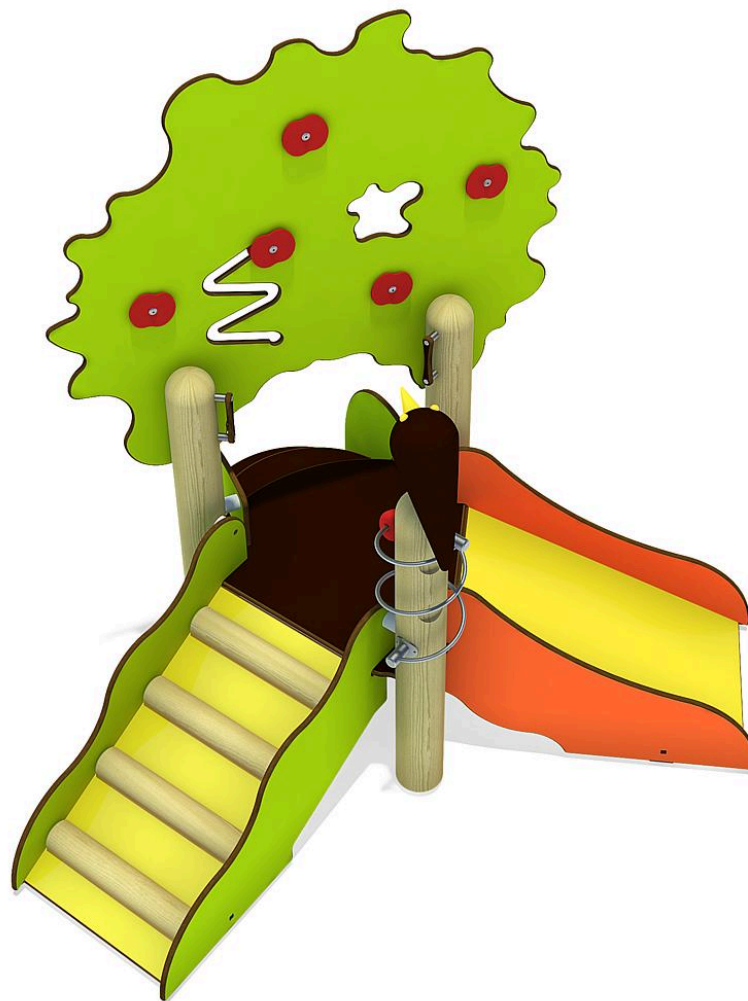

- 1x belly board: high-pressure laminate (HPL)
- 1x climbing ramp: high-pressure laminate (HPL), softwood
- 1x tree backdrop: high-pressure laminate (HPL)
- 1x staircase: high-pressure laminate (HPL)
- 1x platform: high-pressure laminate (HPL)
- 1x play spiral: stainless steel, PE
- 1x set posts with post bases: softwood, galvanised steel













play unit Apple Tree



Technical data

| | | |
|---|---|--------------------|
|  | Material | SW pi |
|  | Minimum space | 5,01x4,46x2,20 m |
|  | Impact protection net | 7,0 m ² |
|  | Free falling height | 40 cm |
|  | Ground constitution GE/NL/B | at least lawn |
|  | Ground constitution all except GE/NL/B | at least lawn |
|  | Largest section | 114x130x1,5 cm |
|  | Heaviest section | 23 kg |
|  | mx. number of users | 6 |
|  | Tested according to standard | EN 1176 - 1/3/7 |
|  | Service interval (in months) | 6 |

Installation information

| | | |
|---|----------------|--------------------------|
|  | Foundations | 9x CF or 3x PFs + 3x PFr |
|  | Fundamentlevel | ET 400 |
|  | Assembly | 2 persons/1.5 h |
|  | PF Accessories | 3x 5632540 + 3x 5632550 |
|  | PF drainage | - |
|  | PF concrete | - |
|  | PF excavation | 1,08 m ³ |
|  | CF Accessories | 6x 5631120 |
|  | CF drainage | - |
|  | CF concrete | 0,10 m ³ |
|  | CF excavation | 0,42 m ³ |

Legend: PF=prefabricated foundation, CF=concrete foundation, ET=burial depth, GFRP=glass-fibre reinforced plastic, VA=stainless steel, PH=platform height



5 59 819 011 00

play unit Apple Tree



CO₂ emissions of the product

325,9 kg

Material share of renewable raw materials

17%

Recyclate content

13%

Circularity score



Weighted emission factor of the product*



Disclaimer:

This dashboard for the circularity index of the 'Circular Product' certification was generated automatically and is based on the corresponding certification of eibe Produktion + Vertrieb GmbH & Co KG, Industriestraße 1, 97285 Röttingen, which was issued on 16 May 2024 by the Gesellschaft für Klimaschutz München GmbH (GKM GmbH) on the basis of the example product Albion play unit from the eibe unique® product line. eibe Produktion + Vertrieb GmbH & Co KG is liable for the accuracy of the contents. The award criteria of the private-law certification 'Circular Product' of GKM GmbH can be viewed at gesellschaft-klimaschutz.de/zertifizierung/zirkularitaet/.

* The CO₂e emissions of the materials used in the product are taken into account. The emissions that arise during the production process are allocated to the product on a pro-rata basis.

created on: 14 August 2024