

# play unit Mia, solo



Age indication



Speed



Fitness



Knowledge

## Scope of delivery



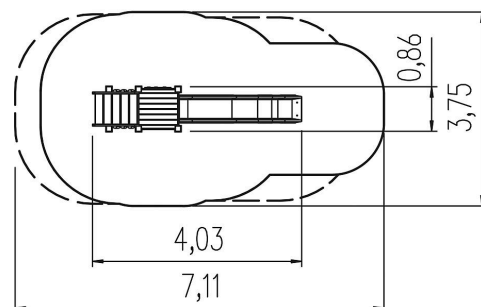
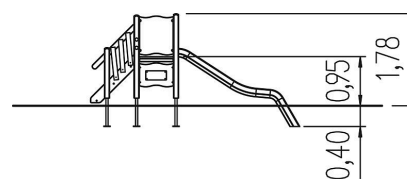





6x post construction: SW  
 6x post shoe: steel galvanised  
 1x platform construction: SW  
 2x wall panel: HPL  
 2x cord protection: HPL  
 1x slide entry plate: HPL  
 1x play panel gear wheel: HPL  
 1x staircase: SW  
 fittings: stainless steel







# play unit Mia, solo



## Technical data

	Material	SW pi
	Minimum space	6,44x3,76x2,75 m
	Impact protection net	18,5 m <sup>2</sup>
	Free falling height	95 cm
	Ground constitution GE/NL/B	at least turf
	Ground constitution all except GE/NL/B	at least turf
	Certificate	Z2_010651_0526_Rev00
	Tested according to standard	EN 1176 - 1/3/7

## Installation information

	Foundations	6x CF or 4x PFs
	Fundamentlevel	ET 400
	Assembly	2 persons/5 h
	PF Accessories	4x 5632540

## Accessories

-  Slides for platform heights: 1x 95 cm
- Installation accessories e.g. PF
- Please order accessories separately to complete the appliance.



# 5 11 003 011 10 play unit Mia, solo

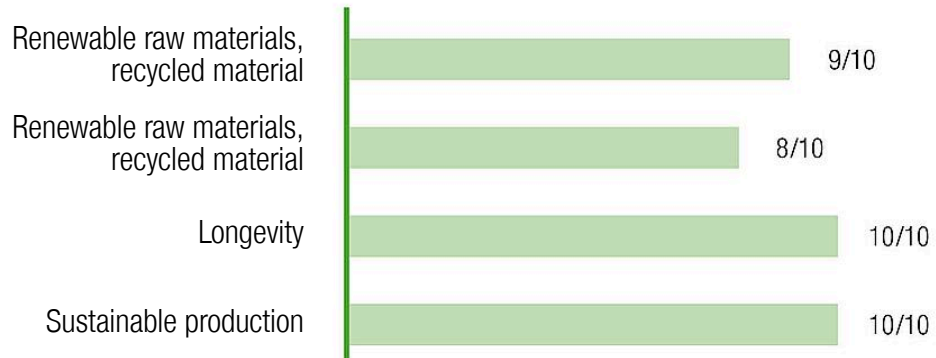

**CO<sub>2</sub> emissions of the product**

**349,6 kg**

**Material share of renewable raw materials**

**65%**

**Recyclate content**

**14%**

Circularity score

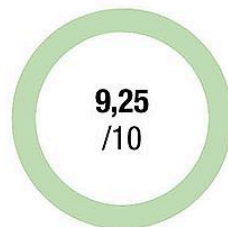

Weighted emission factor of the product\*



**Disclaimer:**

This dashboard for the circularity index of the 'Circular Product' certification was generated automatically and is based on the corresponding certification of eibe Produktion + Vertrieb GmbH & Co KG, Industriestraße 1, 97285 Röttingen, which was issued on 16 May 2024 by the Gesellschaft für Klimaschutz München GmbH (GKM GmbH) on the basis of the example product Albion play unit from the eibe unique® product line. eibe Produktion + Vertrieb GmbH & Co KG is liable for the accuracy of the contents. The award criteria of the private-law certification 'Circular Product' of GKM GmbH can be viewed at [gesellschaft-klimaschutz.de/zertifizierung/zirkularitaet/](https://gesellschaft-klimaschutz.de/zertifizierung/zirkularitaet/).

\* The CO<sub>2</sub>e emissions of the materials used in the product are taken into account. The emissions that arise during the production process are allocated to the product on a pro-rata basis.

created on: 14 August 2024