

hexagonal system 270

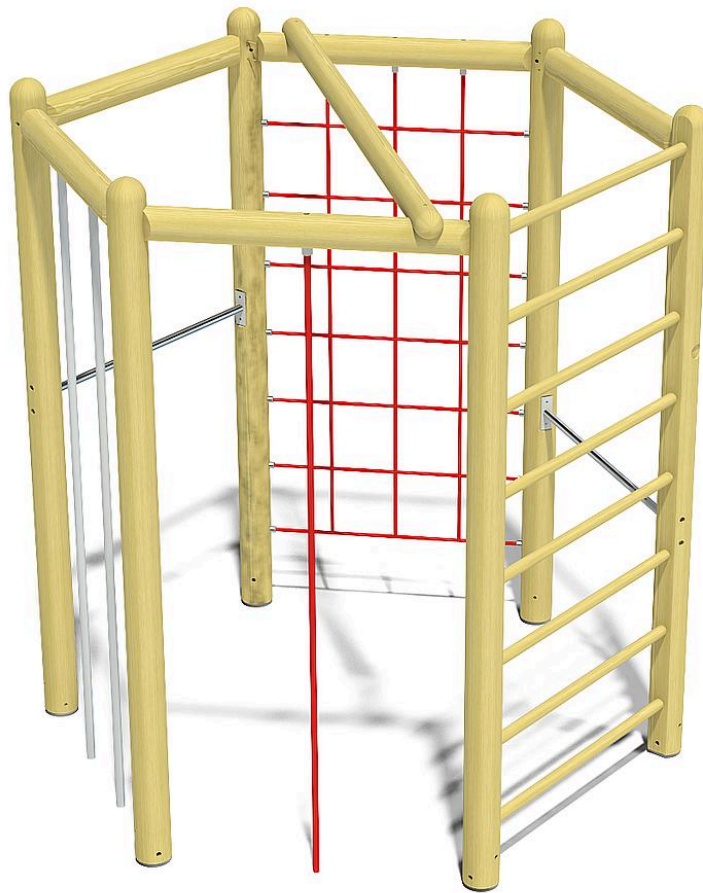

Age indication



Fitness



Living together



Social skills



Senses



Balance

Scope of delivery



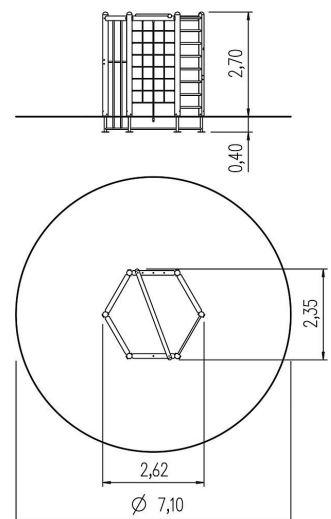





- 1x rung element: softwood, ash
- 2x horizontal bar: galvanised and powder-coated steel
- 2x firemans pole: powder-coated steel
- 1x climbing net: plastic-coated steel cable
- 1x climbing rope: plastic-coated steel cable
- wood structure H 260 cm: softwood
- post shoes: galvanised steel













hexagonal system 270



Technical data

	Material	SW pi
	Minimum space	7,17x6,82x2,70 m
	Impact protection net	39,0 m ²
	Free falling height	265 cm
	Ground constitution GE/NL/B	at least sand
	Ground constitution all except GE/NL/B	at least sand
	Largest section	310x139x14 cm
	Heaviest section	140 kg
	Certificate	TÜV product service
	Tested according to standard	-
	Service interval (in months)	6

Installation information

	Foundations	7x CF or 7x PFs
	Fundamentlevel	ET 400
	Assembly	2 persons/3 h
	PF Accessories	7x 5632540
	PF drainage	-
	PF concrete	-
	PF excavation	-
	CF Accessories	-
	CF drainage	-
	CF concrete	0,34 m ³
	CF excavation	-



5 55 008 5

hexagonal system 270



CO₂ emissions of the product

383,9 kg

Material share of renewable raw materials

80%

Recyclate content

16%

Circularity score



Weighted emission factor of the product*



Disclaimer:

This dashboard for the circularity index of the 'Circular Product' certification was generated automatically and is based on the corresponding certification of eibe Produktion + Vertrieb GmbH & Co KG, Industriestraße 1, 97285 Röttingen, which was issued on 16 May 2024 by the Gesellschaft für Klimaschutz München GmbH (GKM GmbH) on the basis of the example product Albion play unit from the eibe unique® product line. eibe Produktion + Vertrieb GmbH & Co KG is liable for the accuracy of the contents. The award criteria of the private-law certification 'Circular Product' of GKM GmbH can be viewed at gesellschaft-klimaschutz.de/zertifizierung/zirkularitaet/.

* The CO₂e emissions of the materials used in the product are taken into account. The emissions that arise during the production process are allocated to the product on a pro-rata basis.

created on: 14 August 2024