

Active play unit Morro Bay



Age indication



Balance



Speed



Fitness



Social skills



Fine motor skills

Scope of delivery

3x play tower with roof: Powder steel, HDPE, high-pressure laminate (HPL), stainless steel

2x ladder: stainless steel

1x climbing platform: high-pressure laminate (HPL), polyester

1x climbing net: stainless steel, polypropylen

1x wobbly ramp: high-pressure laminate (HPL), polypropylen

1x sliding pole: stainless steel

1x slide ph 180 cm: stainless steel, HDPE



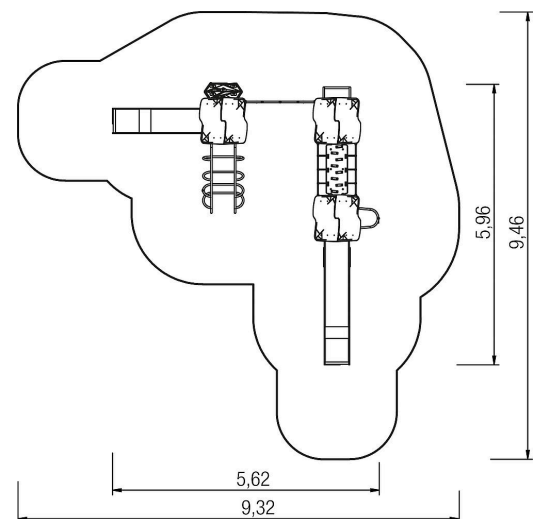





1x slide ph 120 cm: stainless steel, HDPE





Active play unit Morro Bay



Technical data

	Material	Powder steel, HDPE
	Minimum space	9,32x9,46x3,87 m
	Impact protection net	53,0 m ²
	Free falling height	200 cm
	Ground constitution GE/NL/B	at least sand
	Ground constitution all except GE/NL/B	at least sand
	Size	5,62x5,96x3,87 m
	mx. number of users	15

Installation information

	Foundations	18x CF
	Fundamentlevel	FL 3