

# indoor play unit Harbour



Age indication



Fitness



Social skills



Fine motor skills



Imagination



Speed

## Scope of delivery

36x post structure: SW  
 36x post shoe: galvanised steel  
 1x hanging buoy: PVC (durable, phthalate-free)  
 3x hanging cableway seat: rubber, steel  
 1x hanging curtain: artificial leather  
 2x hanging cylinder: foam, artificial leather  
 3x adapter: SW  
 1x balance band: SW, rubber band  
 11x parapet: SW  
 30x parapet: HPL  
 8x decoration window: HPL, plexiglass  
 1x decoration element: HPL  
 2x decoration timber: HPL  
 4x walk-through protection: stainless steel  
 2x gable facing: HPL, Makrolon  
 12x grid roof: SW, HPL, galvanised steel  
 5x set of grips: aluminium, plastic-coated  
 2x roof with tiles: HPL  
 2x obstacle roll: foam, artificial leather, galvanised steel  
 1x suspension bridge sloped: SW, galvanised steel chain  
 3x climbing post: HPL, stainless steel  
 2x climbing board: HPL



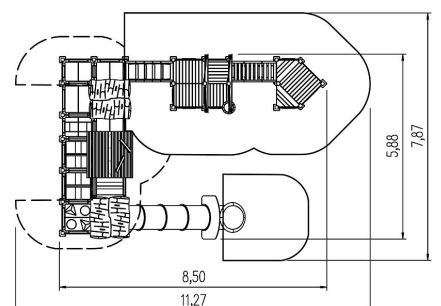
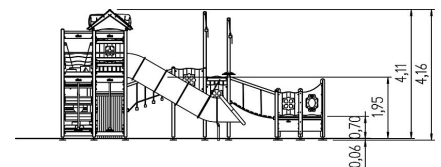



18x net parapet straight: SW, HPL, PE-net  
 8x net parapet: SW, PE-net  
 6x platform cushion: foam, artificial leather, velcro fastener  
 9x platform cushion mat: foam, artificial leather, velcro fastener  
 1x platform cushion ramp: foam, artificial leather, velcro fastener  
 8x platform decoration: HPL  
 9x platform structure: SW  
 1x slide entry plate: HPL  
 1x tubular add-on slide PH 195 cm: GFRP  
 1x pitched roof: SW  
 2x sail: SW, HPL, plastic-coated steel cable  
 1x play panel click wheel: HPL, stainless steel, plastic  
 1x play panel ship: HPL  
 1x play panel ship's wheel: HPL, galvanised steel  
 1x play panel gearwheel: HPL  
 16x play platform mat: SW, plywood, velcro fastener  
 1x wobbly bridge sloped: SW, galvanised steel  
 fittings: stainless steel













# indoor play unit Harbour



## Technical data

	Material	SW pi
	Minimum space	11,27x7,87x4,16 m
	Impact protection net	39,0 m <sup>2</sup>
	Free falling height	145 cm
	Ground constitution GE/NL/B	Synthetic impact attenuation
	Ground constitution all except GE/NL/B	Synthetic impact attenuation
	mx. number of users	-

## Installation information

	Foundations	-
	Fundamentlevel	-
	PF Accessories	-
	PF drainage	-
	PF concrete	-
	PF excavation	-
	CF Accessories	-
	CF drainage	-
	CF concrete	-
	CF excavation	-



5 11 911 012 00

# indoor play unit Harbour



**CO<sub>2</sub> emissions of the product**

**5137,7 kg**

**Material share of renewable raw materials**

**59%**

**Recyclate content**

**10%**

Circularity score



Weighted emission factor of the product\*



**Disclaimer:**

This dashboard for the circularity index of the 'Circular Product' certification was generated automatically and is based on the corresponding certification of eibe Produktion + Vertrieb GmbH & Co KG, Industriestraße 1, 97285 Röttingen, which was issued on 16 May 2024 by the Gesellschaft für Klimaschutz München GmbH (GKM GmbH) on the basis of the example product Albion play unit from the eibe unique® product line. eibe Produktion + Vertrieb GmbH & Co KG is liable for the accuracy of the contents. The award criteria of the private-law certification 'Circular Product' of GKM GmbH can be viewed at [gesellschaft-klimaschutz.de/zertifizierung/zirkularitaet/](https://gesellschaft-klimaschutz.de/zertifizierung/zirkularitaet/).

\* The CO<sub>2</sub>e emissions of the materials used in the product are taken into account. The emissions that arise during the production process are allocated to the product on a pro-rata basis.

created on: 14 August 2024