

active-station cross trainer



Age indication



Fitness



Fine motor skills



Balance

Scope of delivery



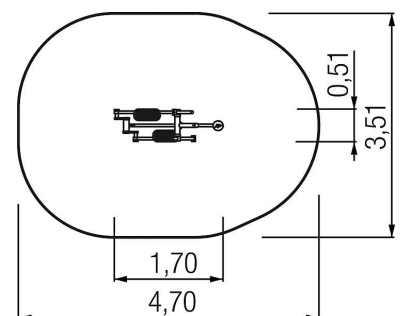
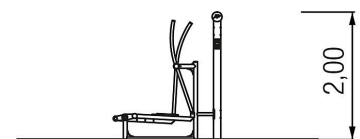



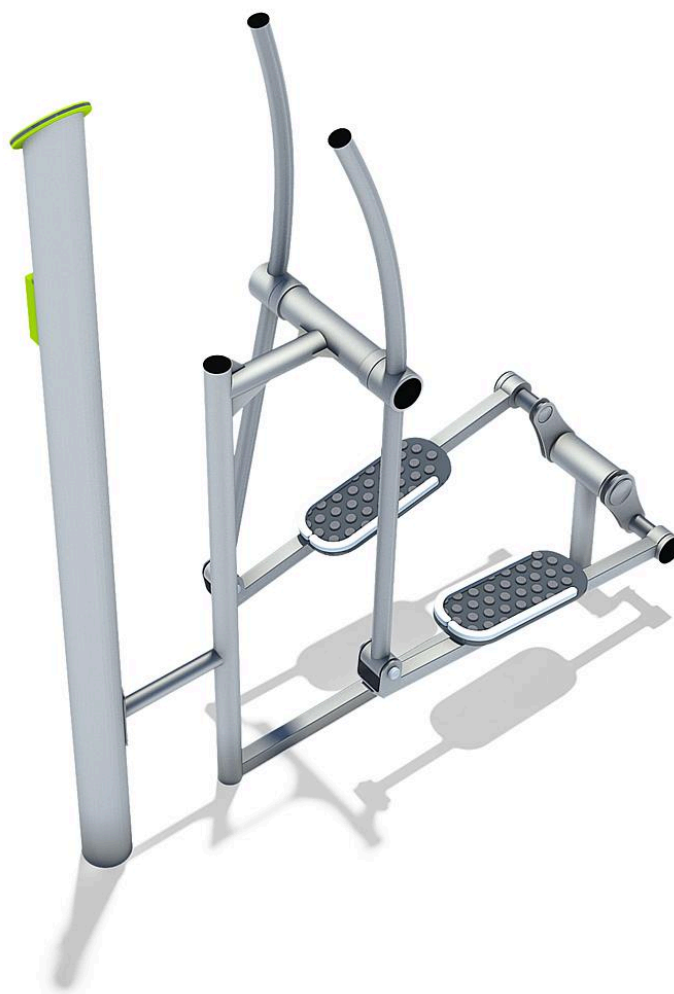

1x active-station: stainless steel, HPL, HDPE



active-station cross trainer



Technical data

	Material	Stainless steel, HDPE
	Minimum space	4,70x3,51x2,67 m
	Impact protection net	2,5 m ²
	Free falling height	47 cm
	Ground constitution GE/NL/B	impact-attenuating tiles
	Ground constitution all except GE/NL/B	impact-attenuating tiles
	Size	1,70x0,51x2,00 m, step height: 47 cm
	mx. number of users	1

Installation information

	Foundations	1x CF
	Fundamentlevel	ET 0
	Assembly	2 persons/2,5 h