

bench with back Schkeud



Recreation

Living to-
gether

Scope of delivery



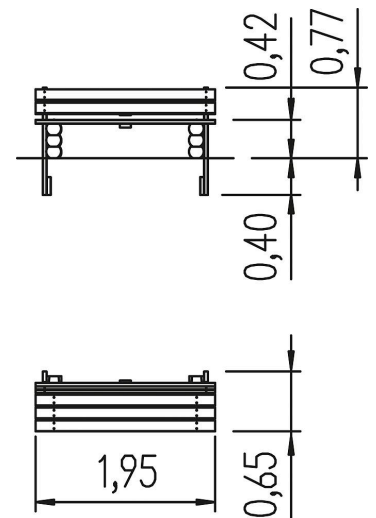





1x bench with backrest : robinia









bench with back Schkeud



Technical data

	Material	Robinia oiled
	Minimum space	-
	Impact protection net	-
	Free falling height	-
	Ground constitution GE/NL/B	at least stone
	Ground constitution all except GE/NL/B	at least stone
	Size	1,95x0,65x0,77 m, sh 42 cm
	Certificate	Z2_010651_0525_Rev00
	Tested according to standard	EN 1176 - 1/7

Installation information

	Foundations	2x CF
	Fundamentlevel	ET 400
	PF Accessories	-
	PF drainage	-
	PF concrete	-
	PF excavation	-



5 45 187 053 00

bench with back Schkeud



CO₂ emissions of the product

40,9 kg

Material share of renewable raw materials

98%

Recyclate content

1%

Circularity score



Weighted emission factor of the product*

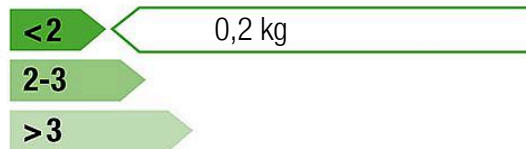

Disclaimer:

This dashboard for the circularity index of the 'Circular Product' certification was generated automatically and is based on the corresponding certification of eibe Produktion + Vertrieb GmbH & Co KG, Industriestraße 1, 97285 Röttingen, which was issued on 16 May 2024 by the Gesellschaft für Klimaschutz München GmbH (GKM GmbH) on the basis of the example product Albion play unit from the eibe unique® product line. eibe Produktion + Vertrieb GmbH & Co KG is liable for the accuracy of the contents. The award criteria of the private-law certification 'Circular Product' of GKM GmbH can be viewed at gesellschaft-klimaschutz.de/zertifizierung/zirkularitaet/.

* The CO₂e emissions of the materials used in the product are taken into account. The emissions that arise during the production process are allocated to the product on a pro-rata basis.

created on: 14 August 2024