

5 55 310 5

balance step 40



Age indication



Fitness



Balance



Social skills



Senses

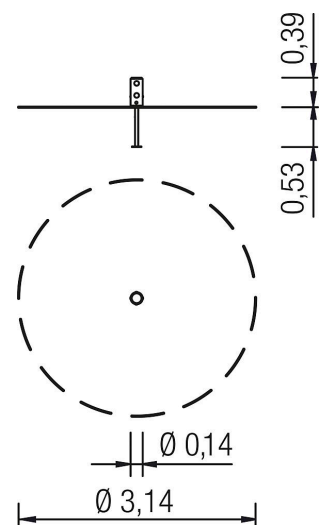

Scope of delivery

1x Step 40: softwood
1x post shoe: galvanised steel















Technical data

	Material	SW pi
	Minimum space	Ø 3,14x2,20 m
	Impact protection net	-
	Free falling height	39 cm
	Ground constitution GE/NL/B	at least stone
	Ground constitution all except GE/NL/B	at least stone
	Largest section	37xØ16 cm
	Heaviest section	6,5 kg
	Certificate	-

Installation information

	Foundations	1x CF
	Fundamentlevel	ET 530
	Assembly	1 person/0.2 h
	PF Accessories	-
	PF drainage	-
	PF concrete	-
	PF excavation	-
	CF Accessories	-
	CF drainage	0,03 m ³
	CF concrete	0,07 m ³
	CF excavation	0,16 m ³

Legend: PF=prefabricated foundation, CF=concrete foundation, ET=burial depth, GFRP=glass-fibre reinforced plastic, VA=stainless steel, PH=platform height



5 55 310 5

balance step 40



CO₂ emissions of the product

34,6 kg

Material share of renewable raw materials

43%

Recyclate content

53%

Circularity score



Weighted emission factor of the product*



Disclaimer:

This dashboard for the circularity index of the 'Circular Product' certification was generated automatically and is based on the corresponding certification of eibe Produktion + Vertrieb GmbH & Co KG, Industriestraße 1, 97285 Röttingen, which was issued on 16 May 2024 by the Gesellschaft für Klimaschutz München GmbH (GKM GmbH) on the basis of the example product Albion play unit from the eibe unique® product line. eibe Produktion + Vertrieb GmbH & Co KG is liable for the accuracy of the contents. The award criteria of the private-law certification 'Circular Product' of GKM GmbH can be viewed at gesellschaft-klimaschutz.de/zertifizierung/zirkularitaet/.

* The CO₂e emissions of the materials used in the product are taken into account. The emissions that arise during the production process are allocated to the product on a pro-rata basis.

created on: 14 August 2024