

5 55 311 5

# balance step 60



Age indication



Fitness



Balance



Social skills



Senses

## Scope of delivery

1x Step 60: softwood  
1x post shoe: galvanised steel

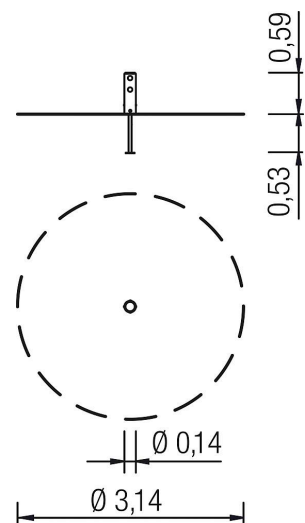













### Technical data

|   |   |                      |
|---|---|----------------------|
|  | Material                                  | SW pi                |
|  | Minimum space                             | Ø 3,14x2,39 m        |
|  | Impact protection net                     | -                    |
|  | Free falling height                       | 59 cm                |
|  | Ground constitution<br>GE/NL/B            | at least stone       |
|  | Ground constitution<br>all except GE/NL/B | at least stone       |
|  | Largest section                           | 57xØ16 cm            |
|  | Heaviest section                          | 10 kg                |
|  | Certificate                               | Z2_010651_0510_Rev00 |

### Installation information

|   |                |                     |
|---|----------------|---------------------|
|  | Foundations    | 1x CF               |
|  | Fundamentlevel | ET 530              |
|  | Assembly       | 1 person/0.2 h      |
|  | PF Accessories | -                   |
|  | PF drainage    | -                   |
|  | PF concrete    | -                   |
|  | PF excavation  | -                   |
|  | CF Accessories | -                   |
|  | CF drainage    | 0,03 m <sup>3</sup> |
|  | CF concrete    | 0,07 m <sup>3</sup> |
|  | CF excavation  | 0,16 m <sup>3</sup> |

Legend: PF=prefabricated foundation, CF=concrete foundation, ET=burial depth, GFRP=glass-fibre reinforced plastic, VA=stainless steel, PH=platform height



5 55 311 5

# balance step 60

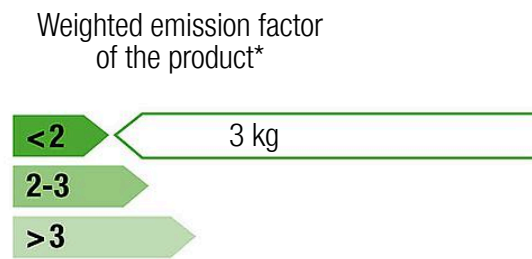
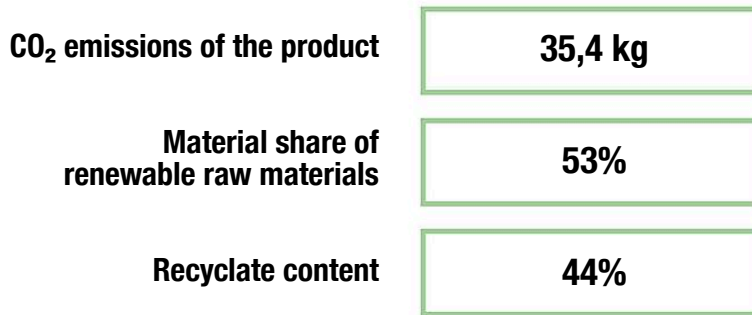

**Disclaimer:**

This dashboard for the circularity index of the 'Circular Product' certification was generated automatically and is based on the corresponding certification of eibe Produktion + Vertrieb GmbH & Co KG, Industriestraße 1, 97285 Röttingen, which was issued on 16 May 2024 by the Gesellschaft für Klimaschutz München GmbH (GKM GmbH) on the basis of the example product Albion play unit from the eibe unique® product line. eibe Produktion + Vertrieb GmbH & Co KG is liable for the accuracy of the contents. The award criteria of the private-law certification 'Circular Product' of GKM GmbH can be viewed at [gesellschaft-klimaschutz.de/zertifizierung/zirkularitaet/](https://gesellschaft-klimaschutz.de/zertifizierung/zirkularitaet/).

\* The CO<sub>2</sub>e emissions of the materials used in the product are taken into account. The emissions that arise during the production process are allocated to the product on a pro-rata basis.

created on: 14 August 2024