

# hammock Swing Fenia

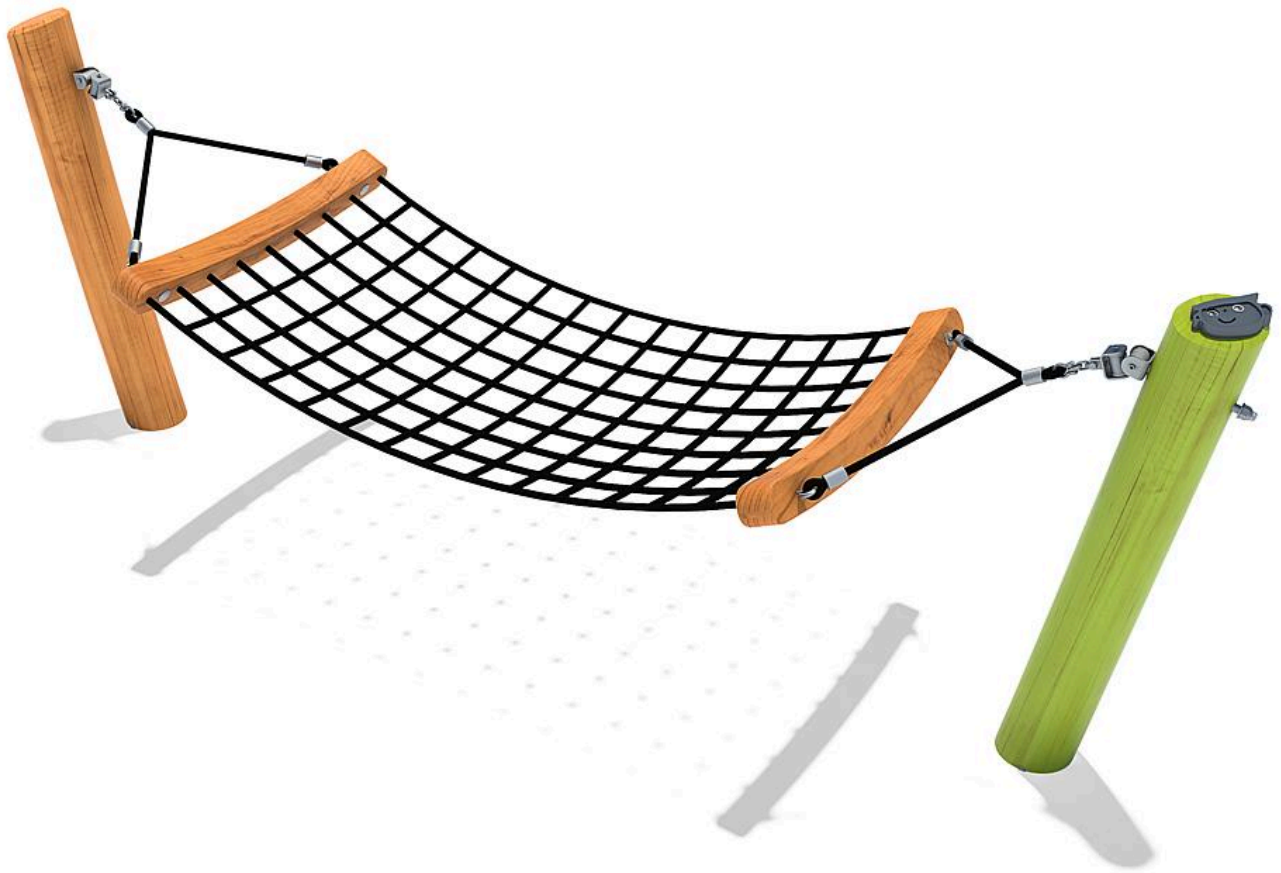

Age indication



Balance



Recreation



Social skills



Senses



Inclusion

## Scope of delivery

2x posts: robinia  
1x hammock: plastic-coated steel cable  
1x set ball joints: stainless steel

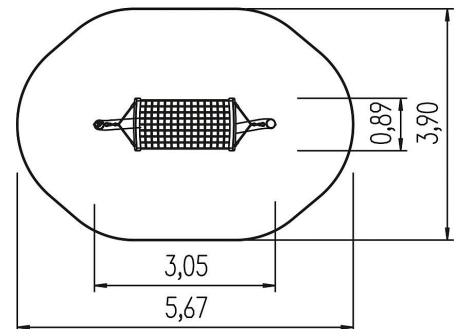
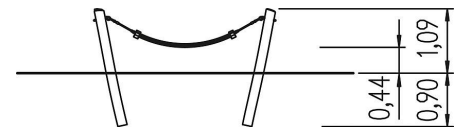



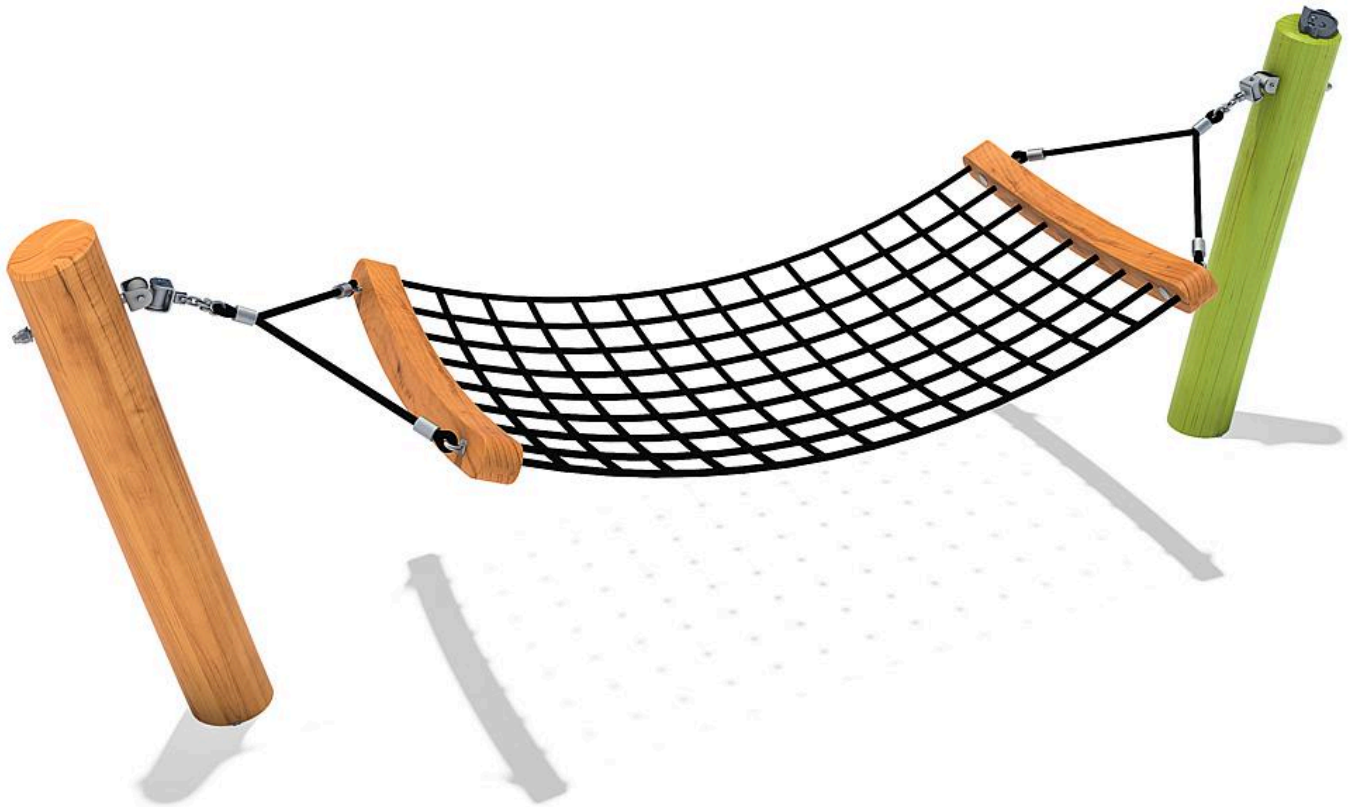







# hammock Swing Fenia



## Technical data

	Material	Robinia oiled
	Minimum space	5,67x3,90x2,80 m
	Impact protection net	18,5 m <sup>2</sup>
	Free falling height	71 cm
	Ground constitution GE/NL/B	at least lawn
	Ground constitution all except GE/NL/B	at least lawn
	Size	3,09x0,80x1,06 m
	Largest section	Ø 20x200 cm
	Heaviest section	80 kg
	mx. number of users	1
	Certificate	-
	Tested according to standard	-

## Installation information

	Foundations	2x CF
	Fundamentlevel	ET 900
	PF Accessories	-
	PF drainage	-
	PF concrete	-
	PF excavation	-
	CF Accessories	-
	CF drainage	0,13 m <sup>3</sup>
	CF concrete	0,64 m <sup>3</sup>
	CF excavation	1,28 m <sup>3</sup>



5 45 004 053 06

# hammock Swing Fenia



**CO<sub>2</sub> emissions of the product**

**98,2 kg**

**Material share of renewable raw materials**

**78%**

**Recyclate content**

**3%**

Circularity score



Weighted emission factor of the product\*

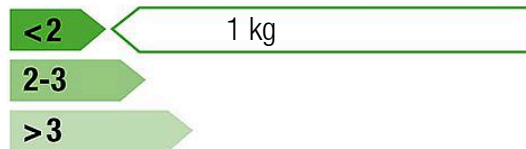

**Disclaimer:**

This dashboard for the circularity index of the 'Circular Product' certification was generated automatically and is based on the corresponding certification of eibe Produktion + Vertrieb GmbH & Co KG, Industriestraße 1, 97285 Röttingen, which was issued on 16 May 2024 by the Gesellschaft für Klimaschutz München GmbH (GKM GmbH) on the basis of the example product Albion play unit from the eibe unique® product line. eibe Produktion + Vertrieb GmbH & Co KG is liable for the accuracy of the contents. The award criteria of the private-law certification 'Circular Product' of GKM GmbH can be viewed at [gesellschaft-klimaschutz.de/zertifizierung/zirkularitaet/](https://gesellschaft-klimaschutz.de/zertifizierung/zirkularitaet/).

\* The CO<sub>2</sub>e emissions of the materials used in the product are taken into account. The emissions that arise during the production process are allocated to the product on a pro-rata basis.

created on: 14 August 2024