

active-station stepper



Age indication



Fitness



Fine motor skills



Balance

Scope of delivery



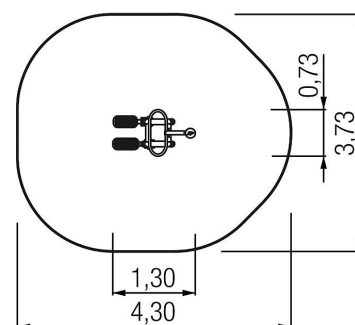





1x active-station: stainless steel, HPL, HDPE



active-station stepper



Technical data

	Material	Stainless steel, HDPE
	Minimum space	4,30x3,73x2,76 m
	Impact protection net	1,5 m ²
	Free falling height	56 cm
	Ground constitution GE/NL/B	impact-attenuating tiles
	Ground constitution all except GE/NL/B	impact-attenuating tiles
	Size	1,30x0,73x2,00 m, step height: 56 cm
	mx. number of users	1

Installation information

	Foundations	1x CF
	Fundamentlevel	ET 0
	Assembly	2 persons/2,5 h