

climbing lizard Rik



Age indication



Imagination



Balance

Scope of delivery



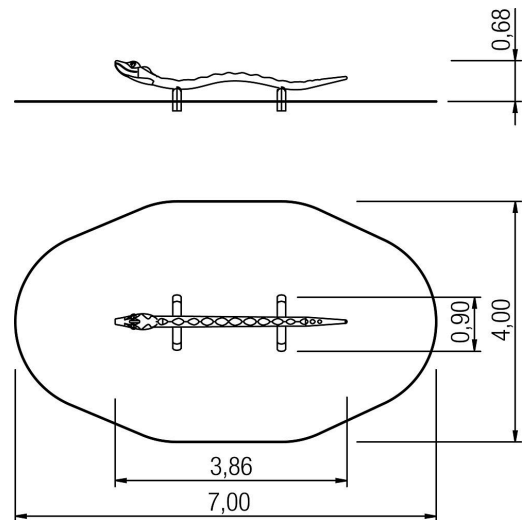





1x carved figure Lizard: robinia









climbing lizard Rik



Technical data

	Material	Robinia natural
	Minimum space	7,00x4,00x2,50 m
	Impact protection net	-
	Free falling height	70 cm
	Ground constitution GE/NL/B	at least lawn
	Ground constitution all except GE/NL/B	at least lawn
	Size	4,00x1,00x0,70 cm
	Certificate	Z2_010651_0535_Rev00
	Tested according to standard	EN 1176 - 1/7

Installation information

	Foundations	4x CF
	Fundamentlevel	ET 500
	Assembly	1 person/2 h
	PF Accessories	-
	PF drainage	-
	PF concrete	-
	PF excavation	-