



STAINLESS STEEL

WALLMOUNTING NOTICE BOARD

Our **wall-mounting stainless steel notice boards** offer a sleek, durable solution for displaying information in public spaces. Built to withstand the elements, they feature a weather-resistant, low-maintenance design with a tough powdercoat finish that suits both modern and traditional environments.

Available in single or double door options, each board includes secure, lockable doors to protect contents from tampering. Ideal for public parks, shopping districts, and civic buildings, this space-saving design delivers reliable performance and a professional appearance year after year.

Product features

- Stainless steel construction
- Can be supplied with or without a header board
- Robust stainless steel locks
- Gas struts to support doors when open
- Tough 4mm clear polycarbonate window
- Vent holes to minimise condensation
- Powdercoat finish to standard colour
- Standard sizes A2, A1 and A0
- 1 year manufacturer's warranty

Specification applies to the standard product.
Our range of options usually allow us to accommodate any differences you may require.
Please contact us and we will be happy to support you in developing this specification to meet your requirements.

Option delete/ update as appropriate

Manufacturer: Fitzpatrick Woolmer,
Unit 7 Lakeside Park, Neptune Close,
Rochester, Kent, ME2 4LT.

Tel: 01634 711 771

Email: info@fwdp.co.uk

Metal: Stainless steel

Grade: 304

Finish: Powdercoat to BS EN 12206:2021 Part 1

Colour: RAL 9005 Black

Fixings: Stainless steel

Type: Security

Weight: 36kg

Guarantee: One year manufacturer's warranty

SCALE - 1 METRE

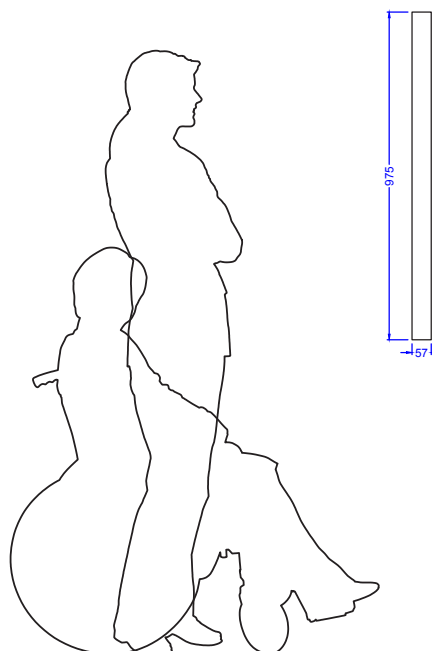

Note:
All dimensions are indicative only.

Specification applies to the standard product. Our range of options usually allow us to accommodate any differences you may require. Please contact us and we will be happy to support you in developing this specification to meet your requirements.

Option delete/ update as appropriate

Manufacturer: Fitzpatrick Woolmer,
Unit 7 Lakeside Park, Neptune Close,
Rochester, Kent, ME2 4LT.

Tel: 01634 711 771

Email: info@fwdp.co.uk

Metal: Stainless steel

Grade: 304

Finish: Powdercoat to BS EN 12206:2021 Part 1

Colour: RAL 9005 Black

Fixings: Stainless steel

Type: Security

Weight: 46kg

Guarantee: One year manufacturer's warranty

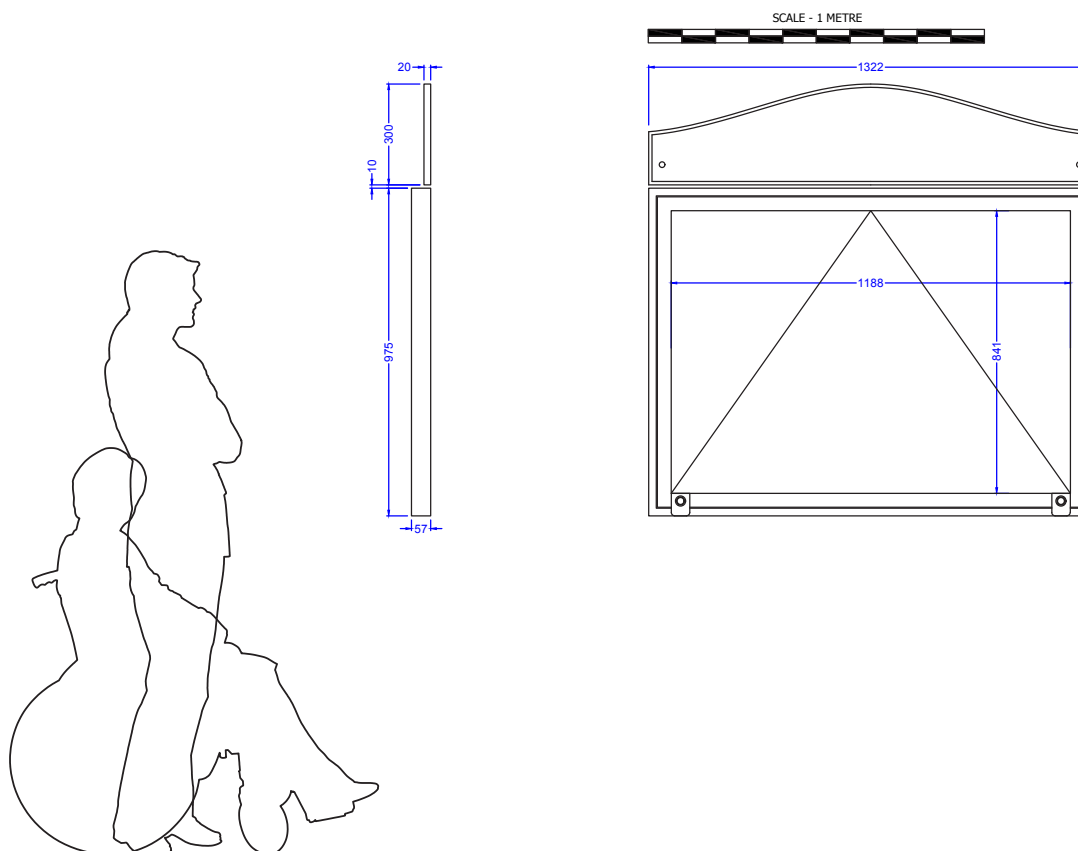

Note:
All dimensions are indicative only.

Specification applies to the standard product.
Our range of options usually allow us to accommodate any differences you may require.
Please contact us and we will be happy to support you in developing this specification to meet your requirements.

Option delete/ update as appropriate

Manufacturer: Fitzpatrick Woolmer,
Unit 7 Lakeside Park, Neptune Close,
Rochester, Kent, ME2 4LT.

Tel: 01634 711 771

Email: info@fwdp.co.uk

Metal: Stainless steel

Grade: 304

Finish: Powdercoat to BS EN 12206:2021 Part 1

Colour: RAL 9005 Black

Fixings: Stainless steel

Type: Security

Weight: 42kg

Guarantee: One year manufacturer's warranty

SCALE - 1 METRE

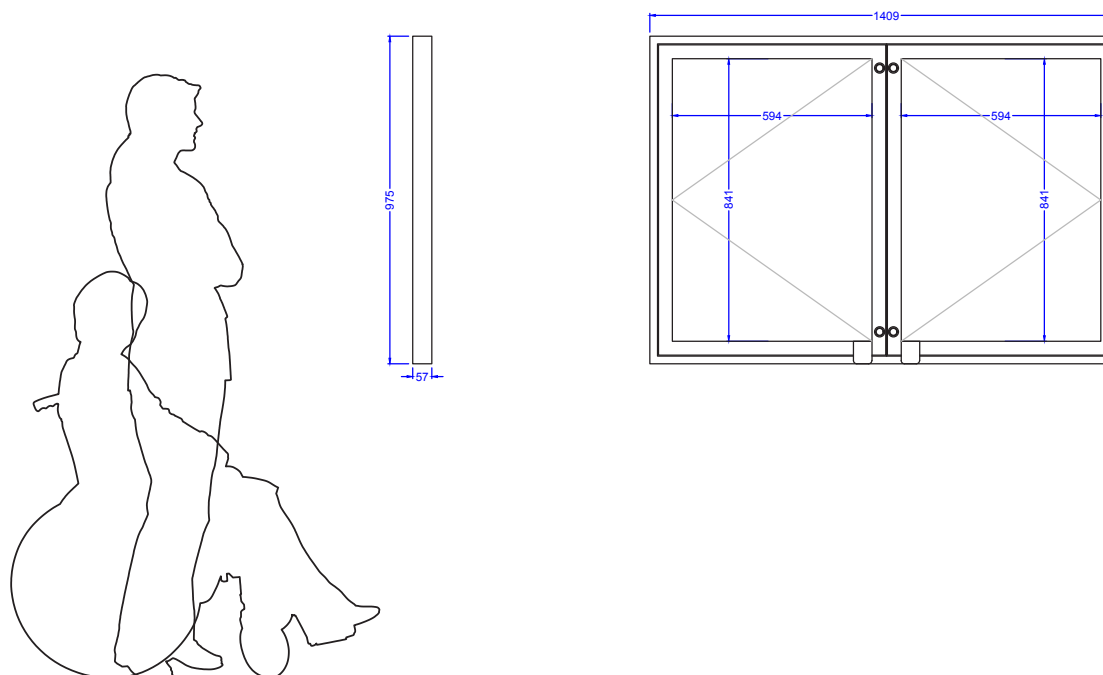

Note:
All dimensions are indicative only.

Specification applies to the standard product. Our range of options usually allow us to accommodate any differences you may require. Please contact us and we will be happy to support you in developing this specification to meet your requirements.

Option delete/ update as appropriate

Manufacturer: Fitzpatrick Woolmer,
Unit 7 Lakeside Park, Neptune Close,
Rochester, Kent, ME2 4LT.

Tel: 01634 711 771

Email: info@fwdp.co.uk

Metal: Stainless steel

Grade: 304

Finish: Powdercoat to BS EN 12206:2021 Part 1

Colour: RAL 9005 Black

Fixings: Stainless steel

Type: Security

Weight: 53kg

Guarantee: One year manufacturer's warranty

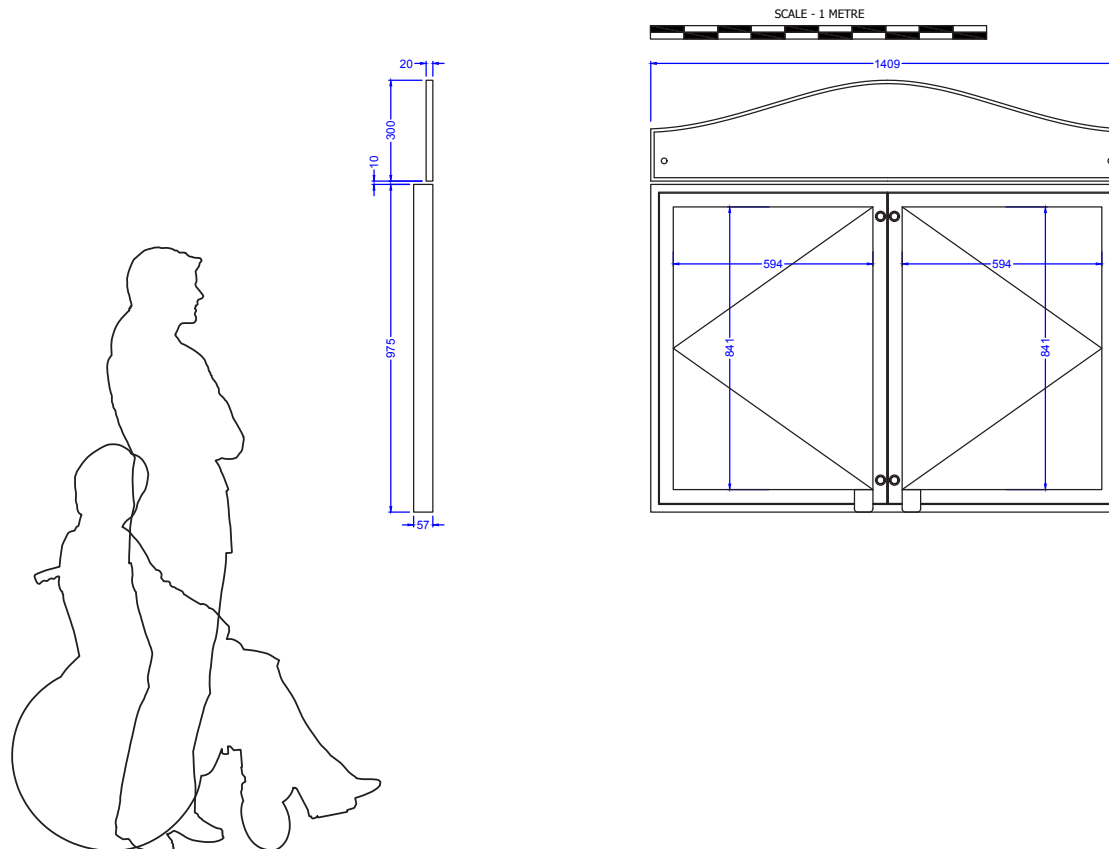

Note:
All dimensions are indicative only.

Specification applies to the standard product.
 Our range of options usually allow us to accommodate any differences you may require.
 Please contact us and we will be happy to support you in developing this specification to meet your requirements.

Option delete/ update as appropriate

Manufacturer: Fitzpatrick Woolmer,
 Unit 7 Lakeside Park, Neptune Close,
 Rochester, Kent, ME2 4LT.

Tel: 01634 711 771

Email: info@fwdp.co.uk

Metal: Stainless steel

Grade: 304

Finish: Powdercoat to BS EN 12206:2021 Part 1

Colour: RAL 9005 Black

Fixings: Stainless steel

Type: Security

Weight: 22kg

Guarantee: One year manufacturer's warranty

SCALE - 1 METRE

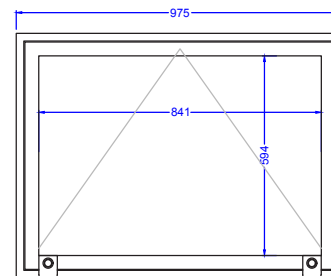
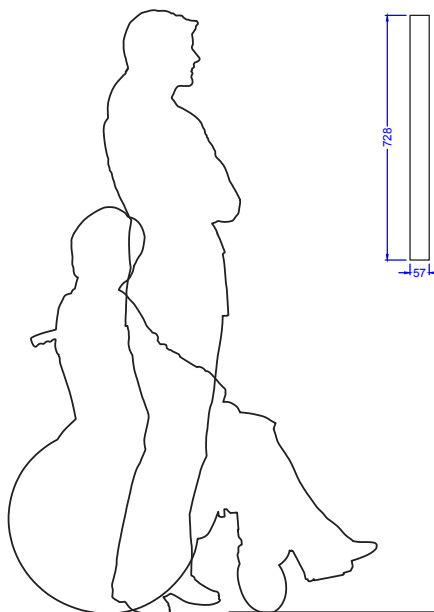

Note:
 All dimensions are indicative only.

Specification applies to the standard product.
 Our range of options usually allow us to accommodate any differences you may require.
 Please contact us and we will be happy to support you in developing this specification to meet your requirements.

Option delete/ update as appropriate

Manufacturer: Fitzpatrick Woolmer,
 Unit 7 Lakeside Park, Neptune Close,
 Rochester, Kent, ME2 4LT.

Tel: 01634 711 771

Email: info@fwdp.co.uk

Metal: Stainless steel

Grade: 304

Finish: Powdercoat to BS EN 12206:2021 Part 1

Colour: RAL 9005 Black

Fixings: Stainless steel

Type: Security

Weight: 28kg

Guarantee: One year manufacturer's warranty

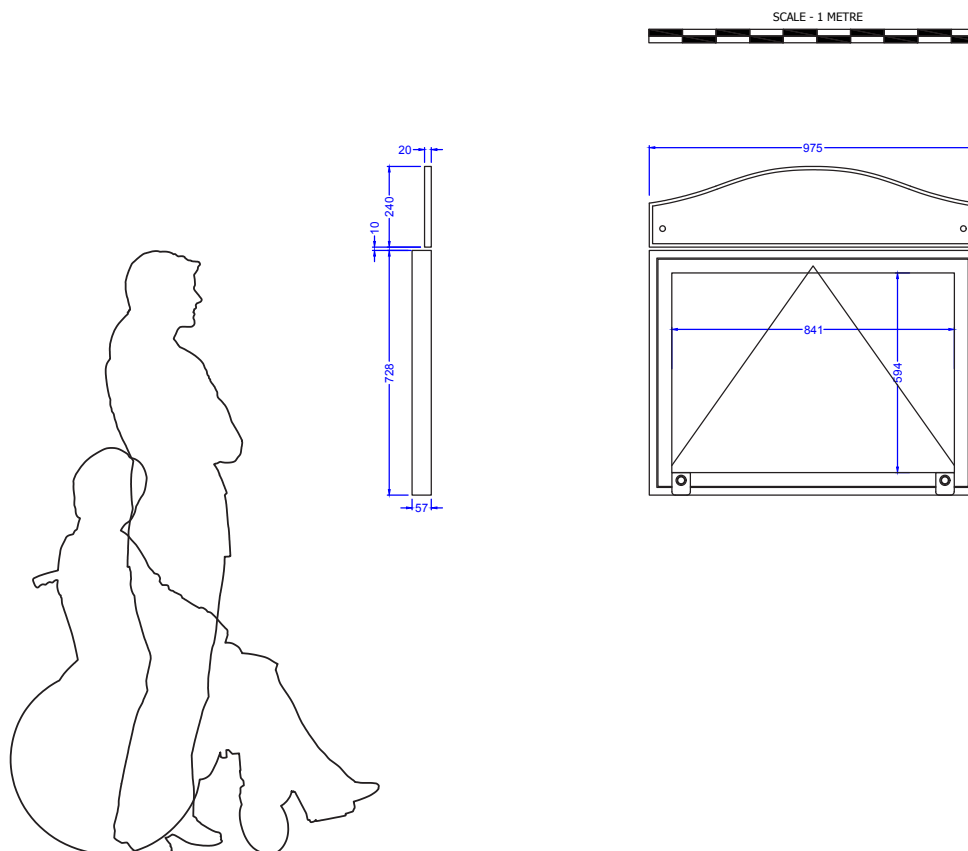

Note:
 All dimensions are indicative only.

Specification applies to the standard product.
Our range of options usually allow us to accommodate any differences you may require.
Please contact us and we will be happy to support you in developing this specification to meet your requirements.

Option delete/ update as appropriate

Manufacturer: Fitzpatrick Woolmer,
Unit 7 Lakeside Park, Neptune Close,
Rochester, Kent, ME2 4LT.

Tel: 01634 711 771

Email: info@fwdp.co.uk

Metal: Stainless steel

Grade: 304

Finish: Powdercoat to BS EN 12206:2021 Part 1

Colour: RAL 9005 Black

Fixings: Stainless steel

Type: Security

Weight: 27kg

Guarantee: One year manufacturer's warranty

SCALE - 1 METRE

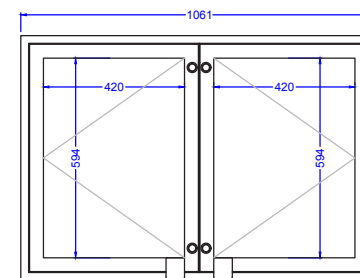
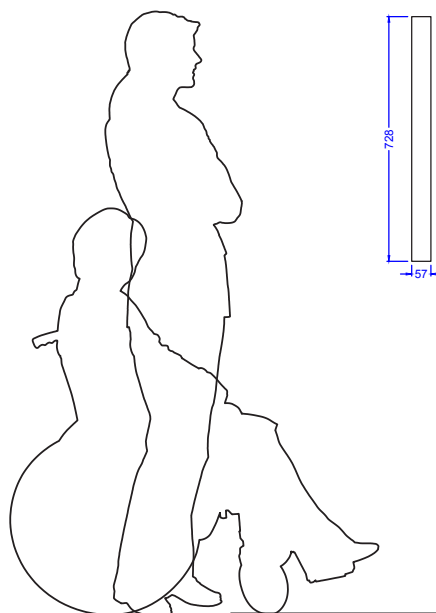

Note:
All dimensions are indicative only.

Specification applies to the standard product.
Our range of options usually allow us to accommodate any differences you may require.
Please contact us and we will be happy to support you in developing this specification to meet your requirements.

Option delete/ update as appropriate

Manufacturer: Fitzpatrick Woolmer,
Unit 7 Lakeside Park, Neptune Close,
Rochester, Kent, ME2 4LT.

Tel: 01634 711 771

Email: info@fwdp.co.uk

Metal: Stainless steel

Grade: 304

Finish: Powdercoat to BS EN 12206:2021 Part 1

Colour: RAL 9005 Black

Fixings: Stainless steel

Type: Security

Weight: 34kg

Guarantee: One year manufacturer's warranty

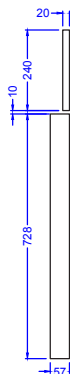
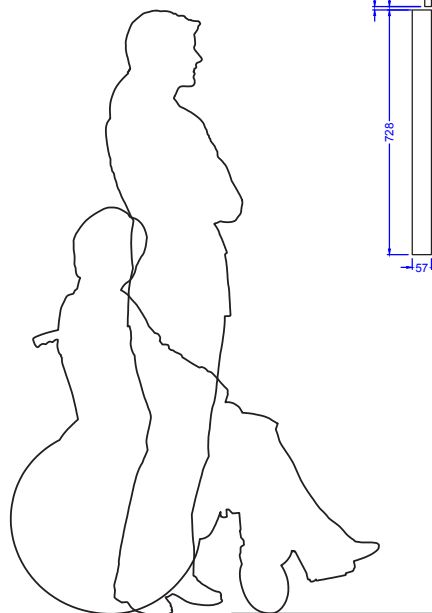

SCALE - 1 METRE

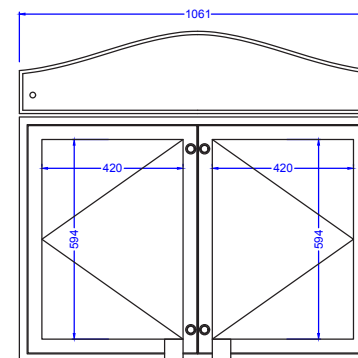

Note:
All dimensions are indicative only.

Specification applies to the standard product.
 Our range of options usually allow us to accommodate any differences you may require.
 Please contact us and we will be happy to support you in developing this specification to meet your requirements.

Option delete/ update as appropriate

Manufacturer: Fitzpatrick Woolmer,
 Unit 7 Lakeside Park, Neptune Close,
 Rochester, Kent, ME2 4LT.

Tel: 01634 711 771

Email: info@fwdp.co.uk

Metal: Stainless steel

Grade: 304

Finish: Powdercoat to BS EN 12206:2021 Part 1

Colour: RAL 9005 Black

Fixings: Stainless steel

Type: Security

Weight: 14kg

Guarantee: One year manufacturer's warranty

SCALE - 1 METRE

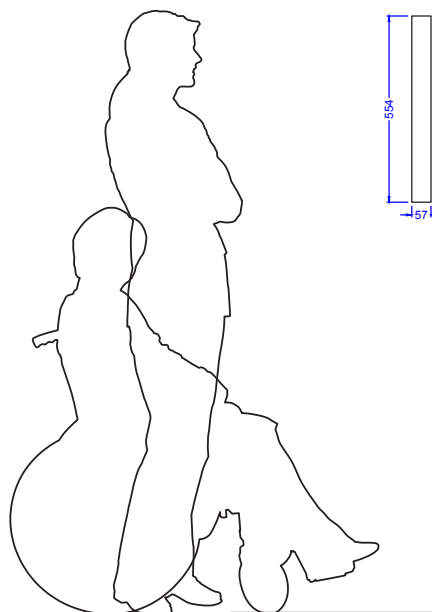

Note:
 All dimensions are indicative only.

Specification applies to the standard product.
 Our range of options usually allow us to accommodate any differences you may require.
 Please contact us and we will be happy to support you in developing this specification to meet your requirements.

Option delete/ update as appropriate

Manufacturer: Fitzpatrick Woolmer,
 Unit 7 Lakeside Park, Neptune Close,
 Rochester, Kent, ME2 4LT.

Tel: 01634 711 771

Email: info@fwdp.co.uk

Metal: Stainless steel

Grade: 304

Finish: Powdercoat to BS EN 12206:2021 Part 1

Colour: RAL 9005 Black

Fixings: Stainless steel

Type: Security

Weight: 18kg

Guarantee: One year manufacturer's warranty

SCALE - 1 METRE

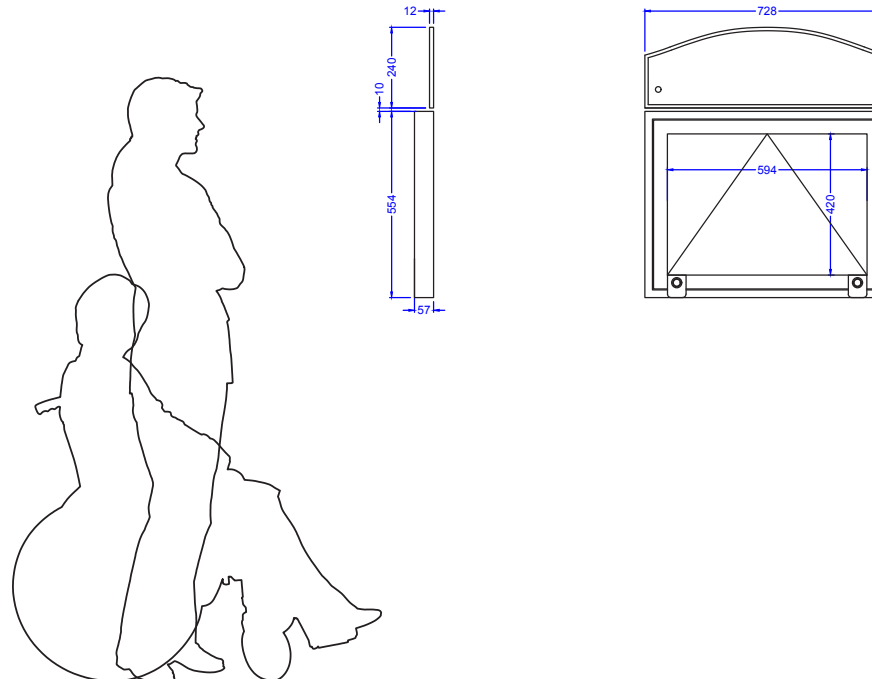

Note:
 All dimensions are indicative only.