

5 59 809 0

Little Beetle spring rocker



Age indication



Balance



Inclusion

Scope of delivery

- 1x spring see-saw-body: powder-coated steel
- 1x seat: PE
- 1x spring: spring steel

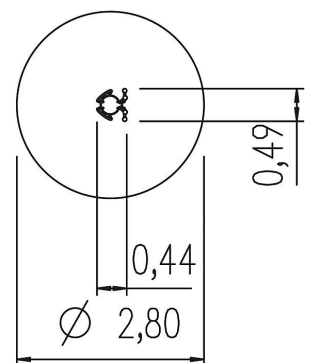
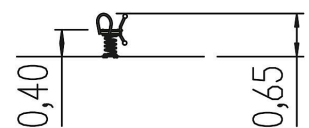





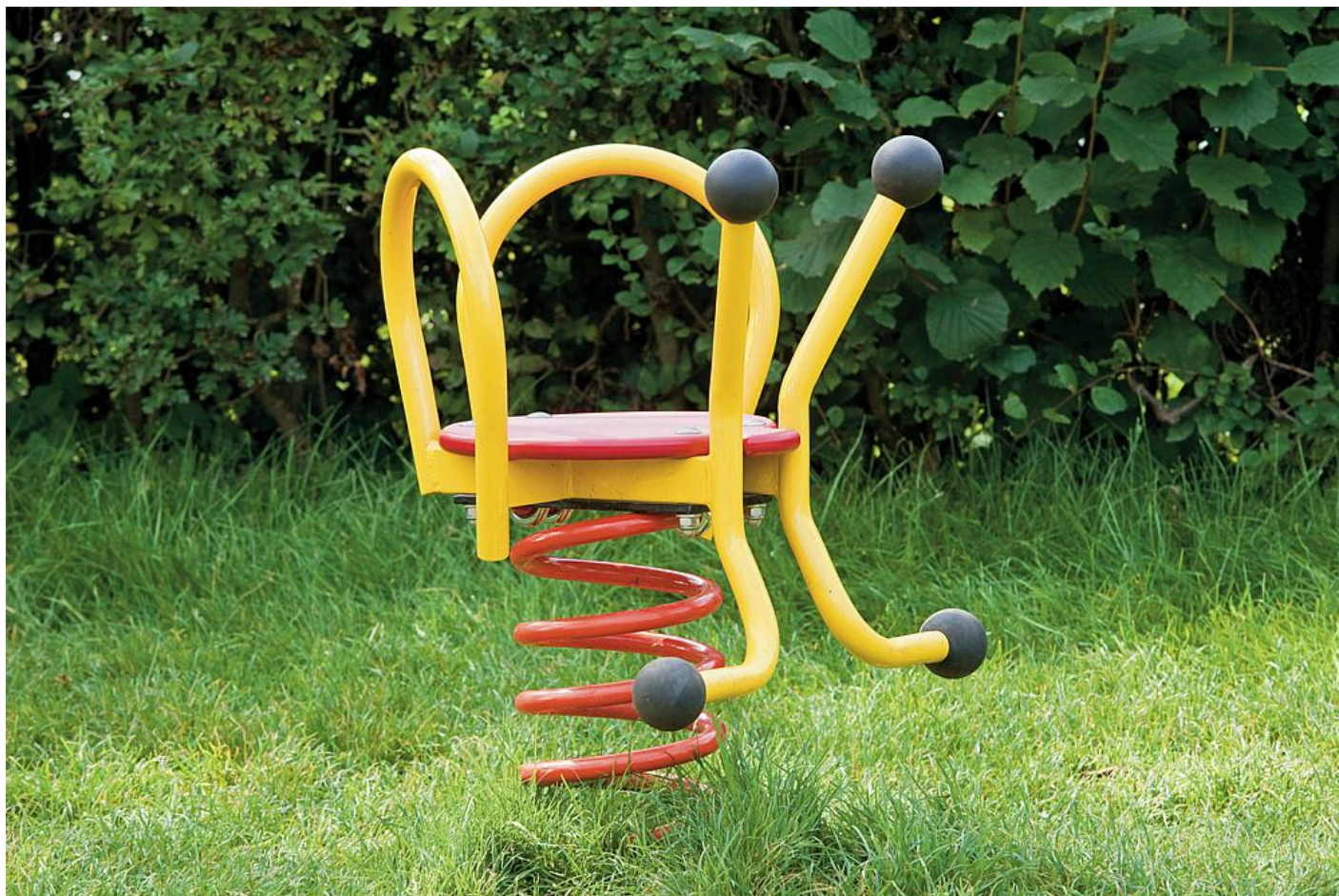







5 59 809 0



Little Beetle spring rocker



Technical data

	Material	Steel, PE
	Minimum space	Ø 2,80x2,40 m
	Impact protection net	6,5 m ²
	Free falling height	40 cm
	Ground constitution GE/NL/B	at least top soil
	Ground constitution all except GE/NL/B	at least top soil
	Size	0,49x0,44x0,65 m, SH 40 cm
	Largest section	45x45x45 cm
	Heaviest section	20 kg
	mx. number of users	1
	Certificate	-
	Tested according to standard	-

Installation information

	Foundations	1x 5591600 + 1x CF or 1x 5632100 + 1x CF
	Fundamentlevel	ET 0 oder ET 450
	Assembly	1 person/1 h

Legend: PF=prefabricated foundation, CF=concrete foundation, ET=burial depth, GFRP=glass-fibre reinforced plastic, VA=stainless steel, PH=platform height



5 59 809 0

Little Beetle spring rocker



CO₂ emissions of the product

178,8 kg

Material share of renewable raw materials

1%

Recyclate content

67%

Circularity score



Weighted emission factor of the product*



Disclaimer:

This dashboard for the circularity index of the 'Circular Product' certification was generated automatically and is based on the corresponding certification of eibe Produktion + Vertrieb GmbH & Co KG, Industriestraße 1, 97285 Röttingen, which was issued on 16 May 2024 by the Gesellschaft für Klimaschutz München GmbH (GKM GmbH) on the basis of the example product Albion play unit from the eibe unique® product line. eibe Produktion + Vertrieb GmbH & Co KG is liable for the accuracy of the contents. The award criteria of the private-law certification 'Circular Product' of GKM GmbH can be viewed at gesellschaft-klimaschutz.de/zertifizierung/zirkularitaet/.

* The CO₂e emissions of the materials used in the product are taken into account. The emissions that arise during the production process are allocated to the product on a pro-rata basis.

created on: 14 August 2024