

safety high rocker

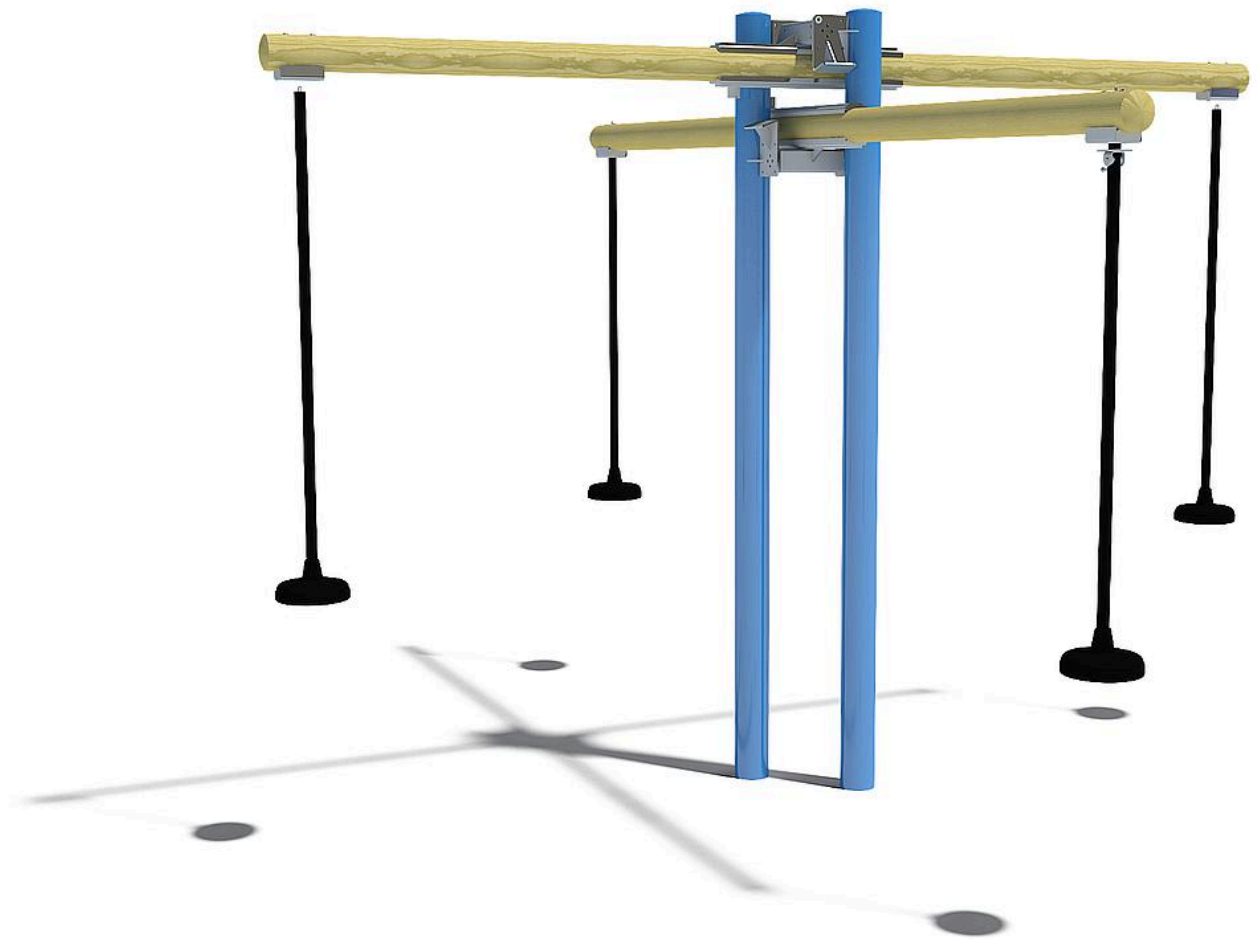

Age indication



Balance



Social skills



Speed

Scope of delivery

2x post: galvanised and powder-coated steel

2x swing beam: softwood

4x seat: rubber

2x low-maintenance joint: stainless steel, rubber

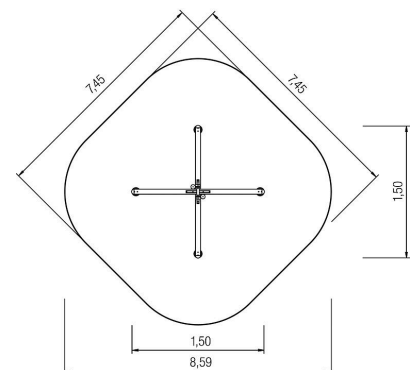
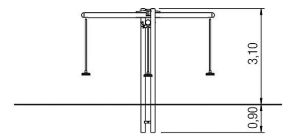

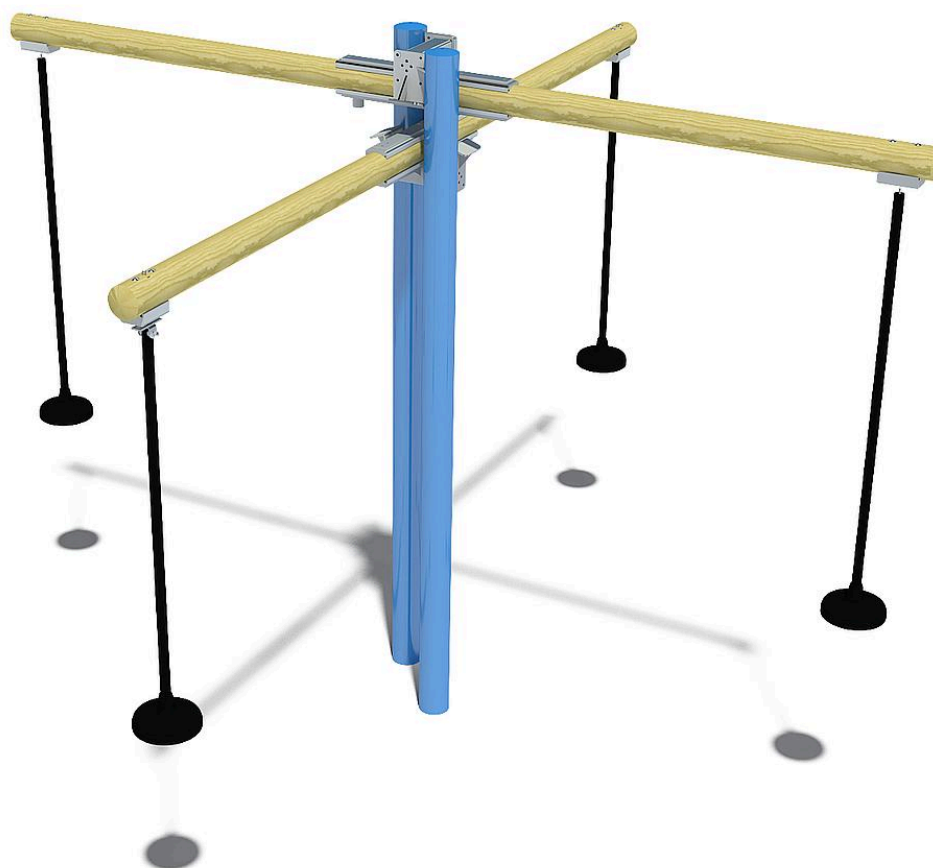

safety high rocker



Technical data

	Material	powdered steel
	Minimum space	7,45x7,45x3,80 m
	Impact protection net	56,0 m ²
	Free falling height	185 cm
	Ground constitution GE/NL/B	at least sand
	Ground constitution all except GE/NL/B	at least sand
	Largest section	29x29x400 cm
	Heaviest section	40 kg
	Certificate	TÜV product service
	Tested according to standard	-
	Service interval (in months)	3

Installation information

	Foundations	1x CF
	Fundamentlevel	ET 900
	Assembly	2 persons/3 h