

tarzan swing with seat

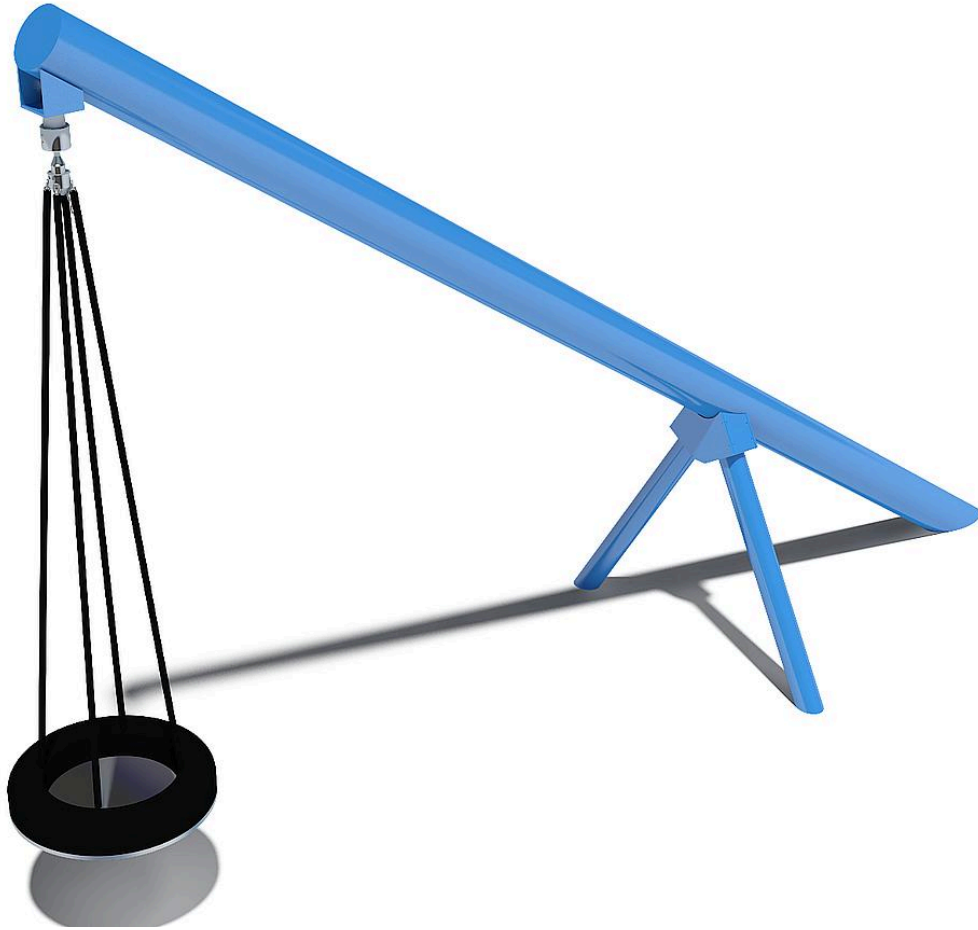

Age indication



Fitness



Speed



Social skills



Senses

Scope of delivery



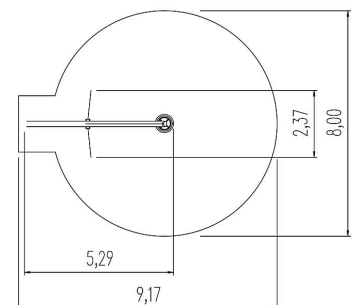
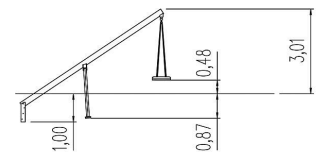



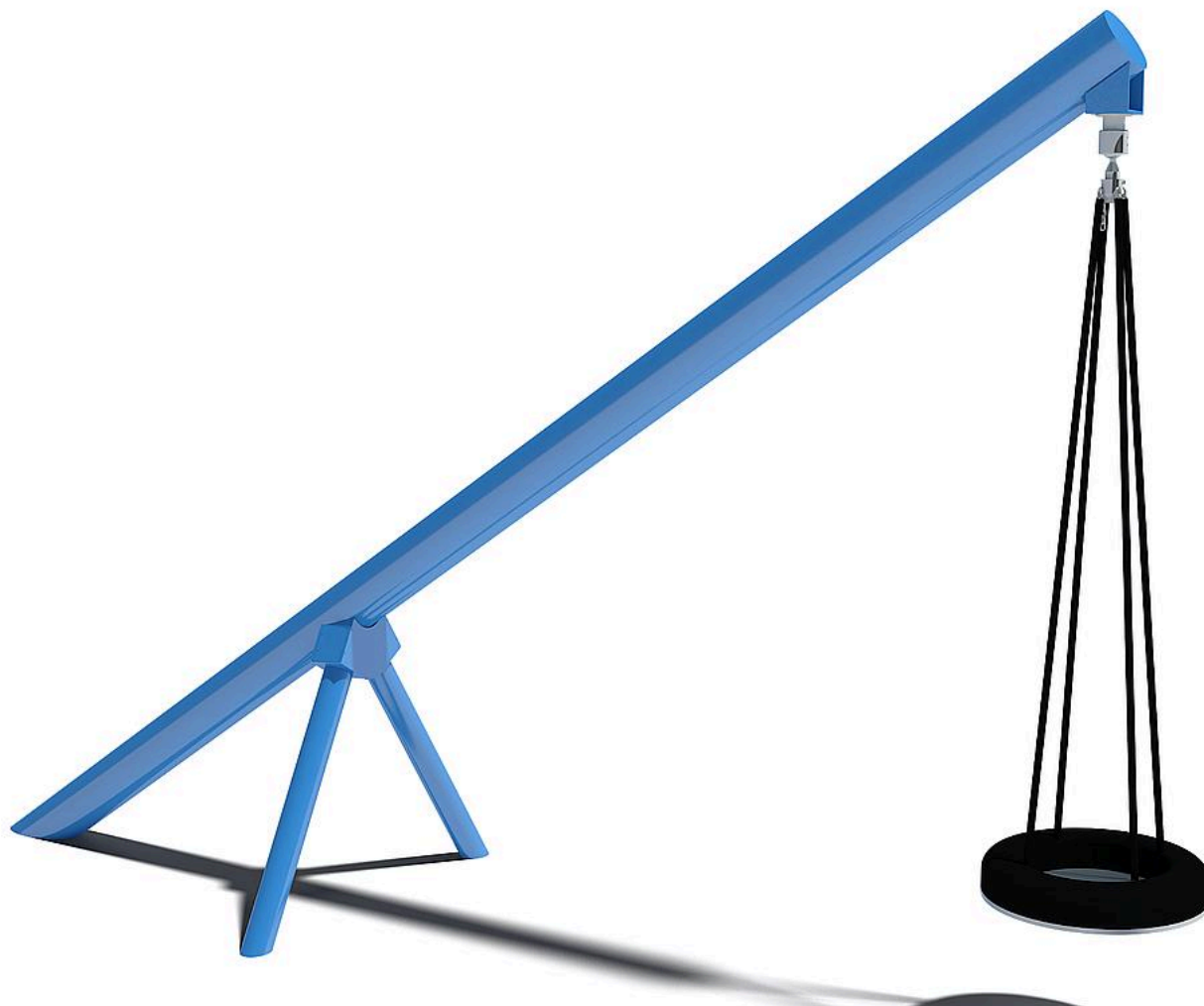





- 1x carrying beam: galvanised and powder-coated steel
- 1x swing seat with chain galvanised steel
- 2x supporting post: galvanised and powder-coated steel
- 1x multiple-point suspension: stainless steel





tarzan swing with seat



Technical data

	Material	powdered steel
	Minimum space	9,17x8,00x3,89 m
	Impact protection net	66,0 m ²
	Free falling height	160 cm
	Ground constitution GE/NL/B	at least sand
	Ground constitution all except GE/NL/B	at least sand
	Largest section	600x30x20 cm
	Heaviest section	150 kg
	mx. number of users	1
	Certificate	ZSTS_APZE_2506
	Tested according to standard	EN 1176 - 1/2/7
	Service interval (in months)	1

Installation information

	Foundations	3x CF
	Fundamentlevel	ET 870
	Assembly	3 persons/3 h