

# circular swing with nest seat



Age indication



Fitness



Social skills



Speed



Living together



Recreation



Senses



Balance



Inclusion

## Scope of delivery



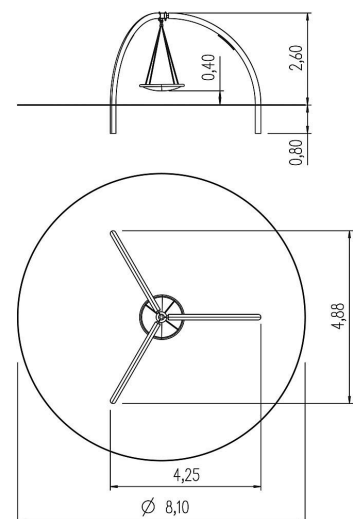



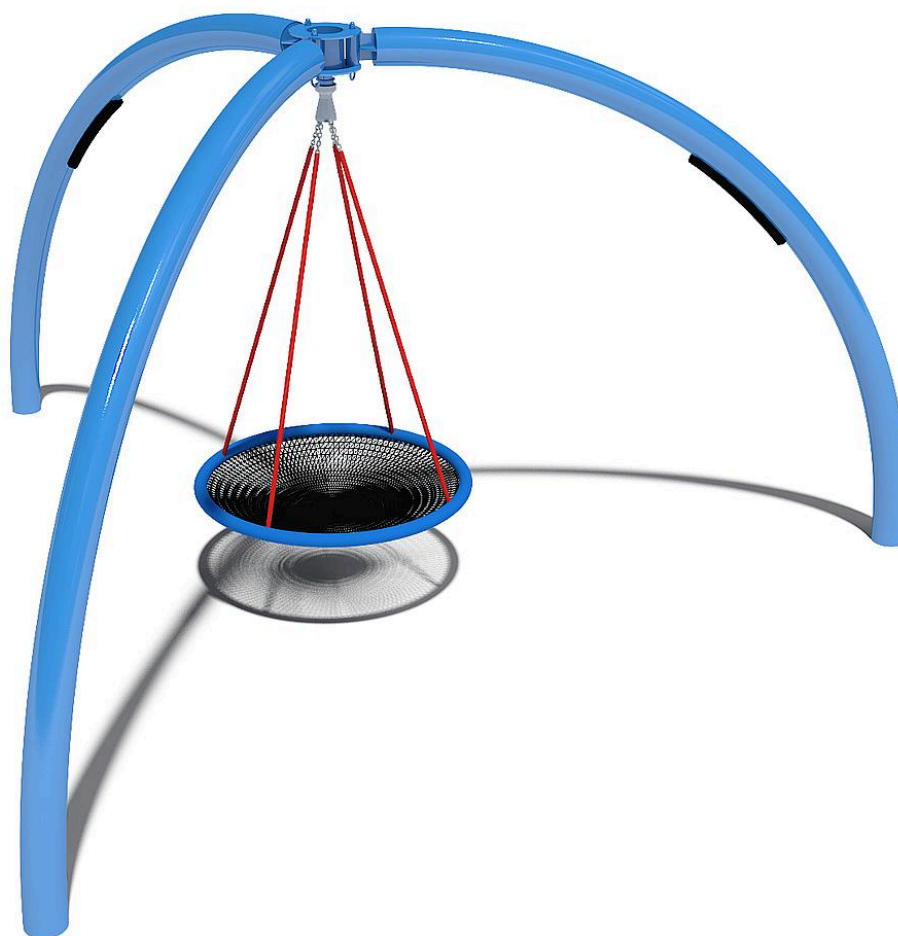

3x posts bent: galvanised and powder-coated steel  
 1x nest swing  $\varnothing = 120$  cm: rope ring, steel cable-link mat,  
 rubber fabric over chain suspension  
 1x multi-point suspension: stainless steel  
 3x impact protection: rubber





# circular swing with nest seat



## Technical data

	Material	powdered steel
	Minimum space	Ø 8,60x4,40 m
	Impact protection net	44,5 m <sup>2</sup>
	Free falling height	150 cm
	Ground constitution GE/NL/B	at least sand
	Ground constitution all except GE/NL/B	at least sand
	Largest section	239x255x12 cm
	Heaviest section	40 kg
	Certificate	ZSTS_APZE_2506
	Tested according to standard	EN 1176 - 1/2/7
	Service interval (in months)	3

## Installation information

	Foundations	3x CF
	Fundamentlevel	ET 800
	Assembly	2 persons/6 h