

three-level horizontal bar Albin



Age indication



Fitness



Social skills



Balance



Inclusion

Scope of delivery

4x posts: robinia

3x horizontal bar: stainless steel

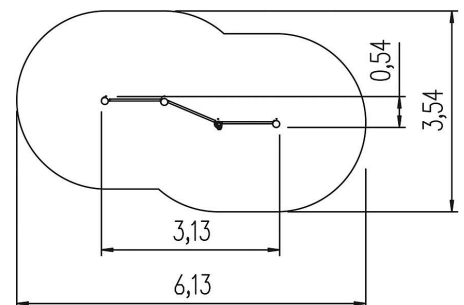
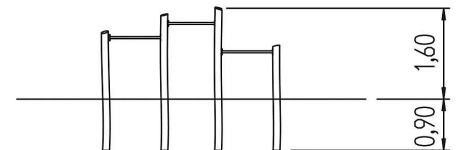







three-level horizontal bar Albin



Technical data

	Material	Robinia oiled
	Minimum space	6,13x3,54x3,20 m
	Impact protection net	17,5 m ²
	Free falling height	135 cm
	Ground constitution GE/NL/B	at least lawn
	Ground constitution all except GE/NL/B	at least lawn
	Size	350x60x170 cm
	Largest section	Ø 16x230 cm
	Heaviest section	50 kg
	Certificate	-
	Tested according to standard	-

Installation information

	Foundations	4x CF
	Fundamentlevel	ET 900
	CF Accessories	-
	CF drainage	0,26 m ³
	CF concrete	1,28 m ³
	CF excavation	2,56 m ³



5 45 015 053 06

three-level horizontal bar Albin



CO₂ emissions of the product

39,3 kg

Material share of renewable raw materials

93%

Recyclate content

5%

Circularity score



Weighted emission factor of the product*



Disclaimer:

This dashboard for the circularity index of the 'Circular Product' certification was generated automatically and is based on the corresponding certification of eibe Produktion + Vertrieb GmbH & Co KG, Industriestraße 1, 97285 Röttingen, which was issued on 16 May 2024 by the Gesellschaft für Klimaschutz München GmbH (GKM GmbH) on the basis of the example product Albion play unit from the eibe unique® product line. eibe Produktion + Vertrieb GmbH & Co KG is liable for the accuracy of the contents. The award criteria of the private-law certification 'Circular Product' of GKM GmbH can be viewed at gesellschaft-klimaschutz.de/zertifizierung/zirkularitaet/.

* The CO₂e emissions of the materials used in the product are taken into account. The emissions that arise during the production process are allocated to the product on a pro-rata basis.

created on: 14 August 2024