

# sand and mud play unit Lana



Age indication



Creativity



Living together



Experiencing the



Social skills

## Scope of delivery



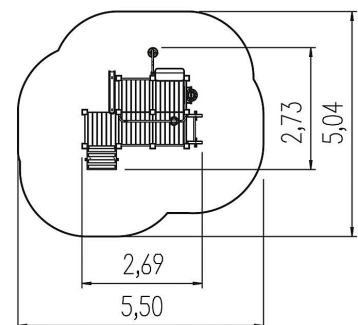
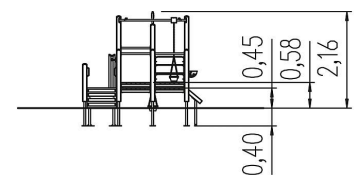





11x post construction: SW  
 11x post shoe: steel galvanised  
 5x platform construction: SW  
 5x walk-through protection leaf: stainless steel  
 2x set of grips: aluminium, plastic coated  
 1x overhead conveyor: stainless steel, rubber  
 1x ladder: SW, rungs stainless steel  
 1x ramp: HPL, SW  
 1x sand lift: stainless steel, rubber  
 1x sand chute: SW  
 1x sand slide: HPL  
 1x sand sieve: stainless steel  
 fittings: stainless steel













# sand and mud play unit Lana



## Technical data

	Material	SW pi
	Minimum space	5,50x5,05x2,38 m
	Impact protection net	23,0 m <sup>2</sup>
	Free falling height	58 cm
	Ground constitution GE/NL/B	at least stone
	Ground constitution all except GE/NL/B	at least stone
	Certificate	Z2_010651_514_Rev00
	Tested according to standard	EN 1176 - 1/7

## Installation information

	Foundations	13x CF or 13x PFs
	Fundamentlevel	ET 400
	Assembly	2 persons/6 h
	PF Accessories	13x 5632540
	PF drainage	-
	PF concrete	-
	PF excavation	1,22 m <sup>3</sup>
	CF drainage	-
	CF concrete	0,77 m <sup>3</sup>
	CF excavation	1,79 m <sup>3</sup>



5 11 028 011 10

# sand and mud play unit Lana



**CO<sub>2</sub> emissions of the product**

**755,9 kg**

**Material share of renewable raw materials**

**68%**

**Recyclate content**

**24%**

Circularity score



Weighted emission factor of the product\*



**Disclaimer:**

This dashboard for the circularity index of the 'Circular Product' certification was generated automatically and is based on the corresponding certification of eibe Produktion + Vertrieb GmbH & Co KG, Industriestraße 1, 97285 Röttingen, which was issued on 16 May 2024 by the Gesellschaft für Klimaschutz München GmbH (GKM GmbH) on the basis of the example product Albion play unit from the eibe unique® product line. eibe Produktion + Vertrieb GmbH & Co KG is liable for the accuracy of the contents. The award criteria of the private-law certification 'Circular Product' of GKM GmbH can be viewed at [gesellschaft-klimaschutz.de/zertifizierung/zirkularitaet/](https://gesellschaft-klimaschutz.de/zertifizierung/zirkularitaet/).

\* The CO<sub>2</sub>e emissions of the materials used in the product are taken into account. The emissions that arise during the production process are allocated to the product on a pro-rata basis.

created on: 14 August 2024