

sand and mud play unit Lara

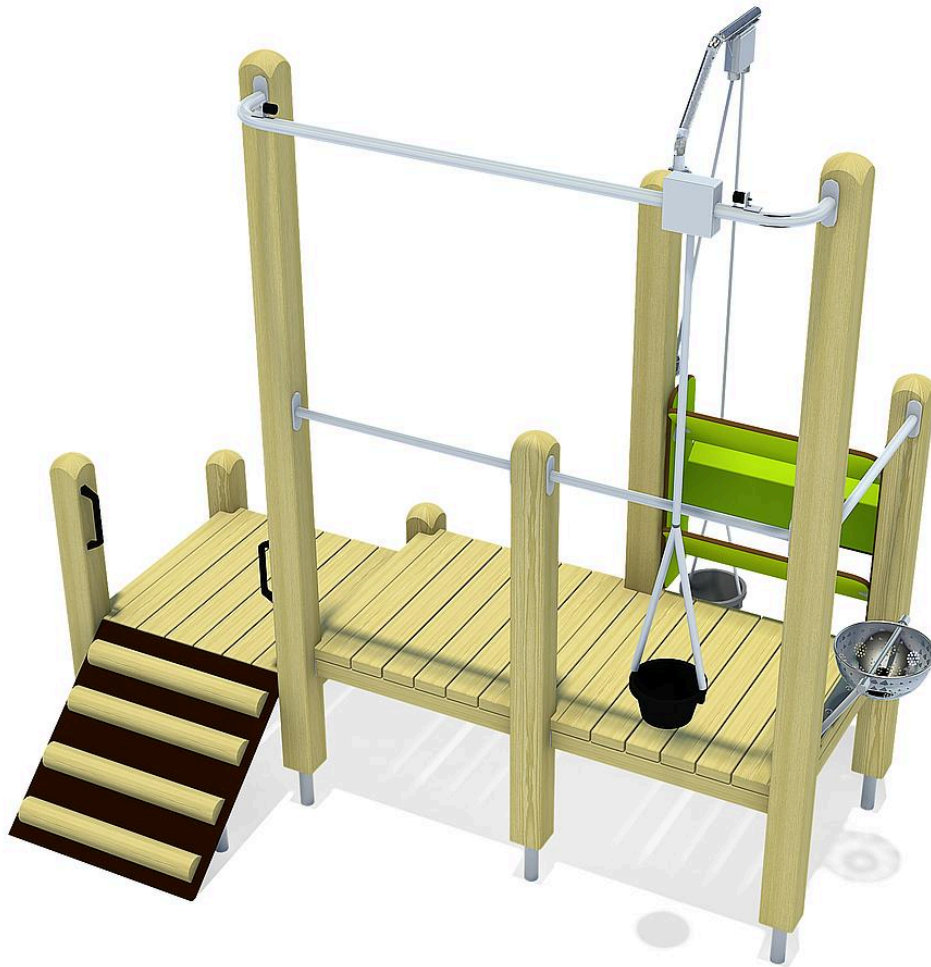

Age indication



Creativity



Living together



Experiencing the



Social skills

Scope of delivery



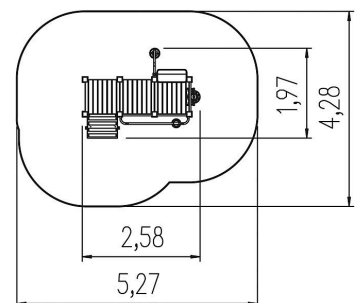
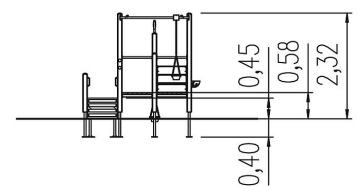



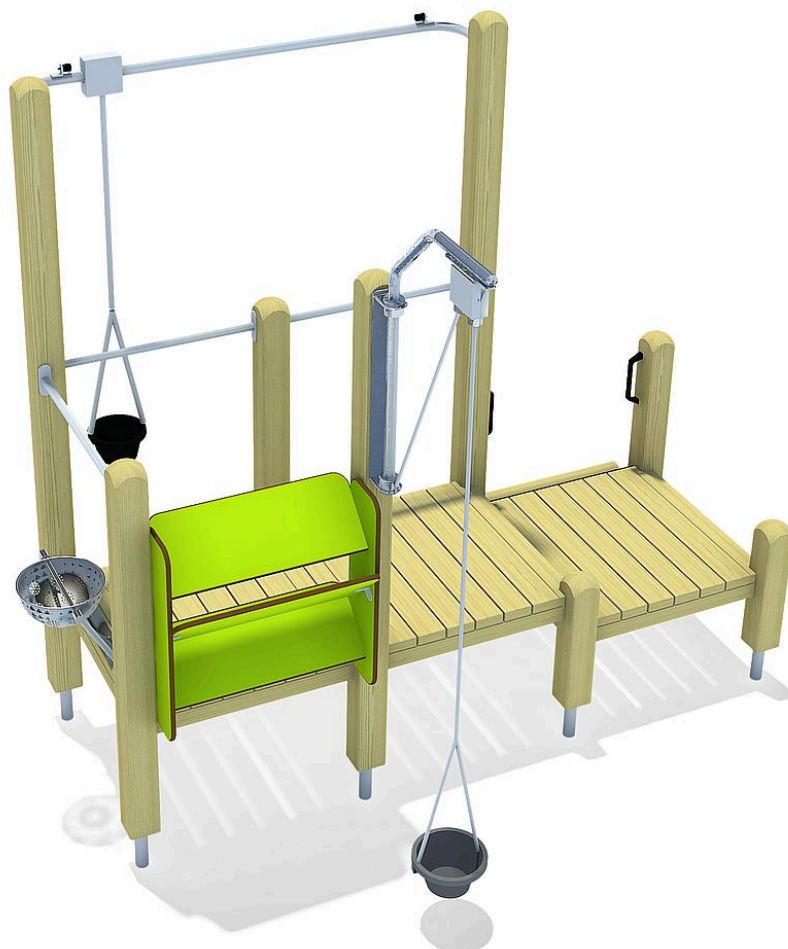

- 8x post construction: SW
- 8x post shoe: steel galvanised
- 3x platform construction: SW
- 3x walk-through protection leaf: stainless steel
- 1x set of grips: aluminium, plastic coated
- 1x overhead conveyor: stainless steel, rubber
- 1x ramp: HPL, SW
- 1x sand lift: stainless steel, rubber
- 1x sand slide: HPL
- 1x sand sieve: stainless steel
- fittings: stainless steel













sand and mud play unit Lara



Technical data

| | | |
|---|---|---------------------|
|  | Material | SW pi |
|  | Minimum space | 5,28x4,29x2,38 m |
|  | Impact protection net | 19,5 m ² |
|  | Free falling height | 58 cm |
|  | Ground constitution GE/NL/B | at least stone |
|  | Ground constitution all except GE/NL/B | at least stone |
|  | mx. number of users | 19 |
|  | Certificate | Z2_010651_514_Rev00 |
|  | Tested according to standard | EN 1176 - 1/7 |

Installation information

| | | |
|---|----------------|---------------------|
|  | Foundations | 9x CF or 9x PFs |
|  | Fundamentlevel | ET 400 |
|  | Assembly | 2 persons/5 h |
|  | PF Accessories | 9x 5632540 |
|  | PF drainage | - |
|  | PF concrete | - |
|  | PF excavation | 0,84 m ³ |
|  | CF drainage | - |
|  | CF concrete | 0,50 m ³ |
|  | CF excavation | 1,18 m ³ |



5 11 027 011 10

sand and mud play unit Lara

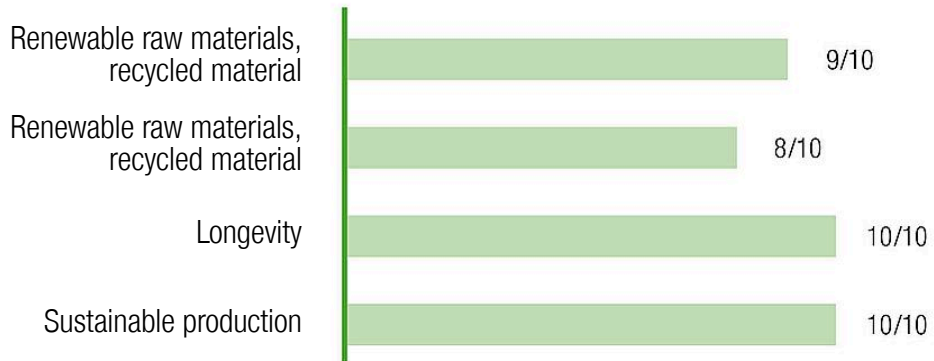

CO₂ emissions of the product

552,3 kg

Material share of renewable raw materials

64%

Recyclate content

26%

Circularity score



Weighted emission factor of the product*



Disclaimer:

This dashboard for the circularity index of the 'Circular Product' certification was generated automatically and is based on the corresponding certification of eibe Produktion + Vertrieb GmbH & Co KG, Industriestraße 1, 97285 Röttingen, which was issued on 16 May 2024 by the Gesellschaft für Klimaschutz München GmbH (GKM GmbH) on the basis of the example product Albion play unit from the eibe unique® product line. eibe Produktion + Vertrieb GmbH & Co KG is liable for the accuracy of the contents. The award criteria of the private-law certification 'Circular Product' of GKM GmbH can be viewed at gesellschaft-klimaschutz.de/zertifizierung/zirkularitaet/.

* The CO₂e emissions of the materials used in the product are taken into account. The emissions that arise during the production process are allocated to the product on a pro-rata basis.

created on: 14 August 2024